

# K<sub>E</sub>T<sub>C</sub>indy Command Reference

K<sub>E</sub>T<sub>C</sub>indy Project Team

August 5, 2021

- ver.3.2 -

## Contents

<b>1</b>	<b>Plane figure</b>	<b>2</b>
1.1	Setting and Defining . . . . .	2
1.1.1	Setting environment . . . . .	2
1.1.2	Drawing and defining . . . . .	4
1.2	Commands for Drawing . . . . .	11
1.2.1	Options of drawing command . . . . .	11
1.2.2	Point, line . . . . .	12
1.2.3	Curved line . . . . .	23
1.2.4	Graph of function . . . . .	34
1.2.5	Letter . . . . .	41
1.2.6	Marking . . . . .	43
1.3	Using plotting data . . . . .	48
1.4	Calculus and I/O . . . . .	59
1.5	Making Tables . . . . .	67
1.6	Data Processing . . . . .	73
1.7	Others . . . . .	76
<b>2</b>	<b>Calling Other Softwares</b>	<b>84</b>
2.1	R . . . . .	84
2.2	Maxima . . . . .	89
2.3	Wolfram Engine . . . . .	93
2.4	Risa/Asir . . . . .	94
2.5	MeshLab . . . . .	95
<b>3</b>	<b>Animation</b>	<b>99</b>
<b>4</b>	<b>K<sub>E</sub>T<sub>C</sub>indy Slide</b>	<b>101</b>
<b>5</b>	<b>K<sub>E</sub>T<sub>C</sub>indy3D</b>	<b>103</b>
5.1	Screen . . . . .	103
5.2	Setting and Defining . . . . .	103
5.3	Command for Drawing . . . . .	106
5.3.1	Point and line . . . . .	106
5.3.2	Polyhedron . . . . .	110
5.3.3	Surface . . . . .	114

5.4	Using Plot data . . . . .	122
5.5	Others . . . . .	132
<b>6</b>	<b>KeTCindyJS</b>	<b>140</b>
6.1	How to create HTML . . . . .	140
6.2	Control of code writing . . . . .	140
6.3	Commands of KeTCindyJS . . . . .	140
<b>7</b>	<b>Appendix</b>	<b>143</b>
7.1	To use other text editor . . . . .	143
7.2	Color table . . . . .	144
7.3	Comparative chart of drawing of points . . . . .	145
<b>8</b>	<b>Command List</b>	<b>146</b>

# 1 Plane figure

## 1.1 Setting and Defining

### 1.1.1 Setting environment

#### Ketinit

**Usage**           Ketinit();

**Description**   Generic function to initialize KeTCindy.

#### Examples

```
Ketinit(); The work sub folder is set to "fig" in the folder of the cindy file.  
Ketinit(""); The work folder is set to the folder of the cindy file.
```

#### Details

This function should be written at the first line on Draw slot page. In case of space figure (KeTCindy's 3D-mode), write it in the initialization slot page `ketlib`.

[⇒Command List](#)

#### Initglist

**Usage**           Initglist(), Setglist(), Addglist()

**Description**   Add the list generated in "ketlib" slot to that of "ketlib" slot.

#### Examples

```
Initglist(); // in ketlib slot  
Implicitplot(''1'',fun,rng);  
Setglist();  
  
Ketinit(); // in figures slot  
Addglist();
```

[⇒Command List](#)

#### Setfiles

**Usage**           Setfiles(filename)

**Description**   Generic function to set the name of texfile.

**Details**        Default file name is working Cinderella file name.

#### Examples

If working Cinderella file name is "triangle.cdy" then default files name are "triangle.tex".  
By `Setfiles("grav");` output files name are "grav.tex".

[⇒Command List](#)

## Setparent

**Usage**           Setparent(filename)

**Description**    Generic function to set the name of texfile by using the Parent push button.

**Details**           There is no default file name when we use the Figpdf() function and the Parent push button, so we have to define the name of output texfile.

### Examples

If working Cinderella file name is "triangle.cdy" , by `Setparent("grav");` output files name are "triangle.tex" and "grav.tex". PDF name is "grav.pdf".

[⇒Command List](#)

## Changework

**Usage**           Changework(name of pass)

**Description**    Generic function to change the working directory(folder).

Default working directory is "fig".

[⇒Command List](#)

## Addpackage

**Usage**           Addpackage(list of style files)

**Description**    Generic function to add packages of T<sub>E</sub>X to the main file for previewing.

**Details**           Basically, `ketpic`, `ketlayer`, `amsmath`, `amssymb`, `graphicx`, `color` are used.

### Examples

```
Addpackage(["[dvipdfmx]{media9}", "[dvipdfmx]{animate}", "ketmedia"]);
```

[⇒Command List](#)

## Usegraphics

**Usage**           Usegraphics("pict2e")

**Description**    This function changes the graphics package to "pict2e".

**Details**           The default package is "tpic".

### Examples

```
Usegraphics("pict2e");
```

[⇒Command List](#)

## 1.1.2 Drawing and defining

### Addax

**Usage**      `Addax(1/0);`

**Description**    Generic function to decide axis are drawn or not.

**Details**        If argument is 1, axis are output in the TeX file (default) but there are no axis on the Euclidean view.

#### Examples

To draw a triangle.

```
Listplot([B,A,C]);  
Letter([A,"ne","A",B,"se","B",C,"se","C"]);
```

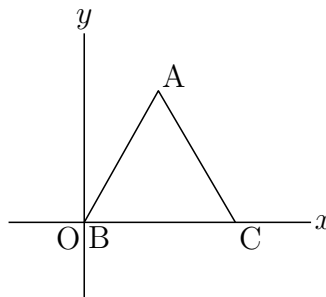

Hide coordinate axes.

```
Addax(0);  
Listplot([B,A,C,B]);  
Letter([A,"ne","A",B,"sw","B",C,"se","C"]);
```

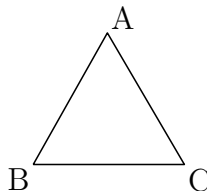

[⇒Command List](#)

### Setax

**Usage**        `Setax(a list of parameters);`

**Description**    Generic function to set the style of axis.

**Details**        Parameters are:

1. Style of axis ("l" ; line(default), "a" : arrow)
2. Name of horizontal ax ( default is x)
3. Posion of horizontal name (default is "e")
4. Name of horizontal ax ( default is y)
5. Posion of horizontal name (default is "n")

6. Name of origin (default is O)
7. Position of origin (default is "sw")
8. Linestyle
9. Color of axes
10. Color of labels

## Examples

```
Setax(["a","","","","","","","nw"]);
Setax(["","","","","","","","do","red"]);
Setax([7,"nw"]);
Setax(["a","\theta","","x","w"]);
```

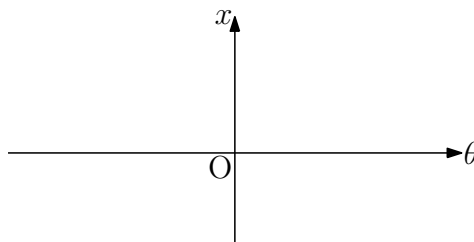

[⇒Command List](#)

## Drwxy

**Usage** Drwxy(), Drwxy(options)

**Description** Generic function to draw axis in the T<sub>E</sub>X figure.

### Details

By default the axes are drawn last. Use this function when axis should be drawn in the middle of commands. There are no axis on the Euclidean view.

Options is a list of ["Origin=", "Xrng=", "Yrng="].

## Examples

To draw a point in the void mode.

```
Setax([7,"se"]);
Setpt(8);
Pointdata("1",[[-pi,0]],["Inside=0"]);
Drwxy();
Plotdata("1","sin(x)","x",["dr","Num=300"]);
Pointdata("2",[pi,0]],["Inside=0"]);
```

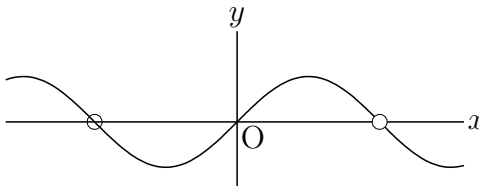

[⇒Command List](#)

## Definecolor

**Usage**      `Definecolor(name of a color,colorcode)`

**Description**    Generic function to define the name of colorcode in the T<sub>E</sub>X figure.

### Examples

```
Definecolor("darkmaz",[0.8,0,0.8]);  
Setcolor("darkmaz");
```

[⇒Command List](#)

## Setcolor

**Usage**      `Setcolor(color,options)`

**Description**    Generic function to set the color of figures and characters in the T<sub>E</sub>X figure.

### Examples

```
C.xy=B.xy/|C.xy|*C.xy;  
Listplot([B,A,C]);  
Setcolor([1,0,0]);  
Anglemark("1",[B,A,C],[3]); //size=3  
Arrowhead(1,"ag1",[2]); //position=1,size=2
```

**Remark**      You can also use color option in each command of drawing.

```
Arrowhead(1,"ag1",["Color=[1,0,0]"]);
```

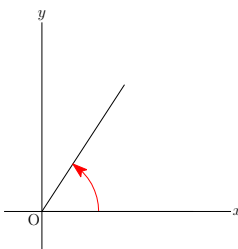
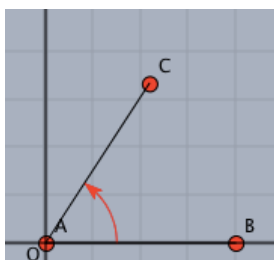

Refer to Color table on Appendix.

[⇒Command List](#)

## Deffun

**Usage**      `Deffun(name of a function,a list of commands);`

**Description**    Generic function to define a function common to both Cindyscript and R.

### Examples

$$f(x) = \frac{1}{x^2 + 1}$$

```
Deffun("f(x)",["regional(y)","y=1/(x^2+1)","y"]);  
Plotdata("1","f(x)","x");
```

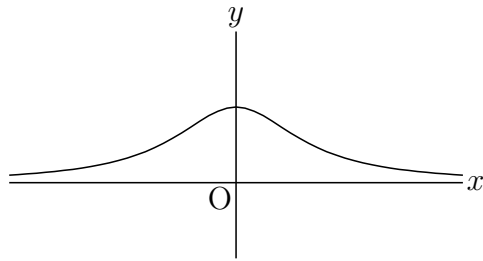

$$f(x) = \begin{cases} 1(x \geq 0) \\ -1(x < 0) \end{cases}$$

```
Deffun("f(x)", ["regional(y)", "if(x>=0,y=1,y=-1)", "y"]);
Plotdata("1", "f(x)", "x", ["Dis=1", "Num=100"]);
```

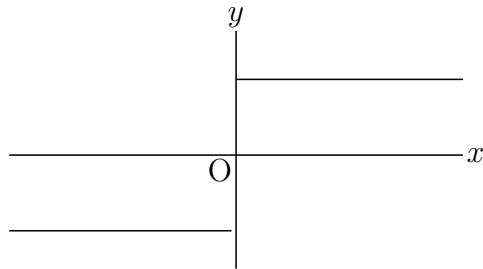

"If" command can be nesting.

```
Deffun("f(x)", ["regional y", "if(x>1,y=1,if(x>-1,y=x,y=-1))", "y"]);
```

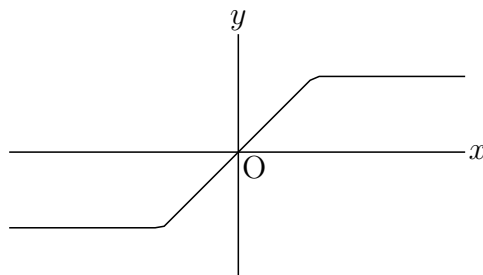

[⇒Command List](#)

## Defvar

**Usage** Defvar([name,value,...]);

**Description** Generic function to define variables common to both Cindyscript and R.

**Examples**

```
Defvar(["const",3]); //const=3;
Defvar(["a",3,"b",1]); //a=3;b=1;
```

[⇒Command List](#)

## FontSize

**Usage** Fontsize(size symbol)

**Description** Generic function to define the font size in the  $\text{\TeX}$  figure.



**Details** The symbol is "t", "ss", "f", "s", "n", "la", "La", "LA", "h", "H".

## Examples

```
Ptsize(2);  
Drawpoint([A,B,C,D,E,F,G]);  
Fontsize("t"); Letter([A,"s2","A"]);  
Fontsize("ss"); Letter([B,"s2","B"]);  
Fontsize("s"); Letter([C,"s2","C"]);  
Fontsize("la"); Letter([D,"s2","D"]);  
Fontsize("La"); Letter([E,"s2","E"]);  
Fontsize("h"); Letter([F,"s2","F"]);  
Fontsize("H"); Letter([G,"s2","G"]);
```

À    Æ    Ć    Đ    È    Ñ    Ğ

[⇒Command List](#)

## Ptsize

**Usage** Ptsize(ratio);

**Description** Generic funtion to set the size of points.

**Details** This function is same as Setpt().

[⇒Command List](#)

## Setpt

**Usage** Setpt(ratio);

**Description** Generic funtion to set the size of points.

**Details** "ratio" is the ratio from the standard size.  
Size can be change as a option of "Pointdata".

## Examples

```
Pointdata("1",A,["Size=1"]);  
Pointdata("2",B,["Size=2"]);  
Pointdata("3",C,["Size=3"]);  
Pointdata("4",D,["Size=4"]);
```

Pointsize 1    2    3    4

[⇒Command List](#)

## Setmarklen

**Usage** Setmarklen(real number)

**Description** Generic function to set the length of tickmarks on the axis.

**Details** Set the length of tickmarks on the axis when we use the functions [Htickmark\(\)](#) and [Vtickmark\(\)](#).

[⇒Command List](#)

## Setorigin

**Usage** Setorigin(coordinate)

**Description** Generic function to set or transtate the coordinate of apparent origin.

### Examples

```
Setorigin([3,2]);  
if A is identification name of some point, Setorigin(A);
```

**Remark** Coordinate system is not changed as the following examples.

### Examples

The coordinate of apparent origin is (3,2) but we use the original coordinate system in the script.

```
Setorigin([3,2]);  
Listplot([A,B,C,A]);  
Ptsize(3);  
Drawpoint([1,1]);  
Letter([[1,1], "s2", "P"]);
```

Left figure is Euclidean view, right figure is the result of T<sub>E</sub>X.

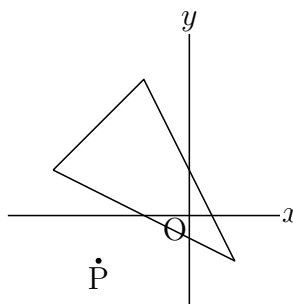
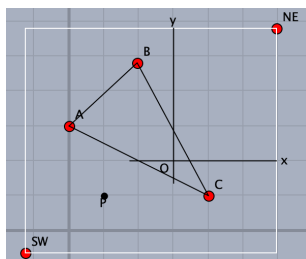

[⇒Command List](#)

## Setpen

**Usage** Setpen(real number)

**Description** Generic function to set the thickness of lines.

[⇒Command List](#)

## Setscaling

**Usage**        Setscaling(scale)

**Description**    Generic function to set the scale of vertical direction. Argument is real number or list. If it is a real number, vertical scaling. If the list [a, b], scaling a in the horizontal direction and b in the vertical direction.

### Examples

```
Setscaling(0.5);  
Plotdata("1", "-2*x^2+10*x", "x");  
p1=[5/2,0]; p2=[5/2,25/2]; p3=[0,25/2];  
Listplot(`1", [p1,p2,p3], ["da"]);  
Expr([[5,0], "s2w", "5", p3, "w2", "\frac{25}{2}", p1, "s4", "\frac{5}{2}"]);
```

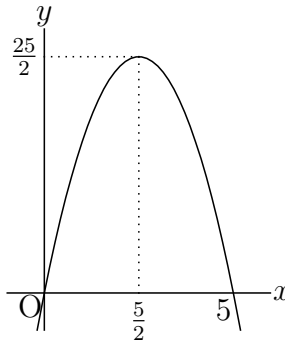

[⇒Command List](#)

## Setunitlen

**Usage**        Setunitlen(scale);

**Description**    Generic function to set the scale of unit length. (default is 1cm)  
It is recommended to put this function to the beginning of a script.

### Examples

```
Setunitlen("8mm");
```

[⇒Command List](#)

## Setwindow

**Usage**        Setwindow(range of x , range of y);

**Description**    Generic function to set a output area on a Euclidean view.

**Details**        A output area is normally specified by a rectangle with SW and NE as diagonal two vertices. (i.e range of x is [XMIN,XMAX] and range of y is [YMIN,YMAX]) By dragging these two vertices on a Euclidean view, we can change the output area. This command is used to set the window manually and fix it.

## Examples

```
Setwindow([-5,5],[-1,3]);
```

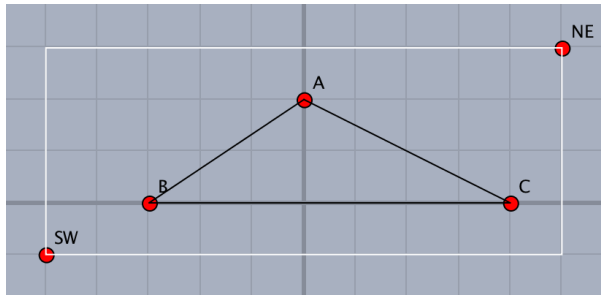

[⇒Command List](#)

## 1.2 Commands for Drawing

### 1.2.1 Options of drawing command

#### Options of drawing command

Line type

"dr, n"	solid line
	n : thickness
"da(,m,n)"	broken line
	m : length, n : gap
	m,n option are not draw Euclidean view and can be omitted.
"id(,m,n)"	broken line start gap.
"do(,m,n)"	dot line
	m : gap, n : thickness

Color

"Color=col" : col: RGB or CMYK or color name

Num

"Num=n" : Number of divisions of plotting data

Example

```
Plotdata("1", "x^2", "x", ["Color=red", "do,2,3", "Num=100"]);
```

Output

"notex"	not output to T <sub>E</sub> X.
"nodisp"	not output to T <sub>E</sub> X and Euclidean view but make PD.
"Size=n"	size of point and thin of line
"Num=n"	Number of PD

Direction

The direction is represented by e(east : right), w(west: left), n(north : upper), s(south:lower) and c(center). The distance from the specified position can also be given as a numerical value. For example, "e2" and "e3" are placed twice and three times of the slightly unit distance away from "e", respectively.

Others

In addition, there are options specific to each function.

[⇒Command List](#)

### 1.2.2 Point, line

#### Pointdata

**Usage**            Pointdata(name, point list, options)

**Description**    Generic function to create point data.

**Detailse**        Options are "Size=", "Color=", "Inside=", "notex/nodisp".

**Examples**

```
Pointdata("1", [[1,2], [-2,3]]); // make 2 points (1,2),(-2,3)
Pointdata("2", [A,B]); // A and B are draw by drawing tool.
Pointdata("3", A, ["size=4"]); // size of point A is 4.
Pointdata("4", [A,B], ["Inside=n"]); // only circles
Pointdata("4", [A,B], ["Inside=white"]); // inside painted with white
Pointdata("5", [[3,4], [5,6]], ["notex"]); //not draw in the TEXfile.
Pointdata("6", [[3,4], [5,6]], ["nodisp"]); //not draw TEXfile and Euclidean view.
```

Draw node of tree.

```
Ptsize(3);
Pointdata("1", [[1,2], [3,4], [5,2]]);
Listplot("1", [[0,0], [1,2], [3,4], [5,2], [4,0]]);
Listplot("2", [[1,2], [2,0]]);
Listplot("3", [[5,2], [6,0]]);
```

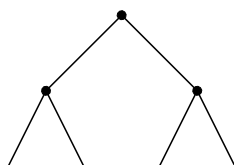

**Remark**            [Comparative chart of drawing of points](#)

[⇒Command List](#)

#### Putpoint

**Usage**            Putpoint(name of point, A, B);

**Description** Generic function to put a point.

**Details** Put a point at A. If there already exists a point at A, it is put at B.

### Examples

```
Putpoint("P", [1,1]); // P is fixed point.
Putpoint("P", [1,1], [P.x,P.y]); // for a movable point.
```

**Remark** [Comparative chart of drawing of points](#)

[⇒Command List](#)

## Putintersect

**Usage** Putintersect(name of point, PD1 ,PD2, [Number] )

**Description** Generic function to make a intersection point of two curves.

**Details** PD1 and PD2 are plotting data names of two curves. Only one intersection point exists inside the drawing range, we have the point. If there exist many intersection points inside the drawing range then we have the list of coordinates for the points and the message:"Choose point number" on the console. The "Number" argument is this point number. We have to use the function Pointdata() when we need the figure of points in the output T<sub>E</sub>Xfile.

### Examples

In the following example We have three intersection points for a cubic curve and a line.

```
Plotdata("1", "x^3-4*x", "x", ["Num=200"]);
Plotdata("2", "1/2*x+1", "x");
Putintersect("P", "gr1", "gr2", 1);
Putintersect("Q", "gr1", "gr2", 2);
Putintersect("R", "gr1", "gr2", 3);
Pointdata("1", [P,Q,R], ["size=4"]);
```

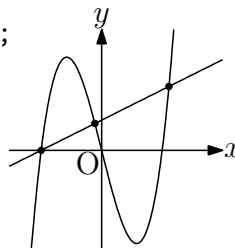

If there exist no such points, we have the message:"No intersect point" on the console.

[⇒Command List](#)

## PutonCurve

**Usage** PutonCurve(name of point, PD, options);

**Description** Generic function to put a point on the curve.

**Details** Put a point on the curve of PD.

### Examples

```
Paramplot("1", "[2*cos(t)^3,2*sin(t)^3]", "t=[0,2*pi]");
PutonCurve("P", "gp1", [-1,1]);
```

This Point P on the asteroid can be move along the curve on the Euclidean view.

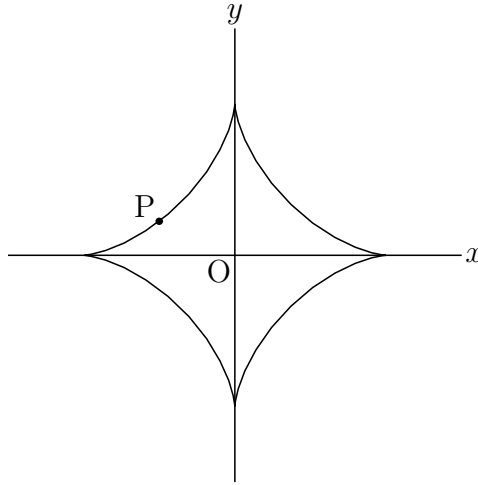

[⇒Command List](#)

## PutonLine

**Usage** PutonLine(name of point, A, B);

**Description** Generic function to put a point on the line.

**Details** Put a point on the straight line through the two points A and B.

### Examples

```
PutonLine("P",A,B);
```

[⇒Command List](#)

## PutonSeg

**Usage** PutonSeg(name of point, A, B);

**Description** Generic function to put a point on the segment.

**Details** Put a point on the line segment AB.

### Examples

```
PutonSeg("P",A,B);
```

[⇒Command List](#)

## Reflectpoint

**Usage** Reflectpoint(a point, center or axis of symmetry);

**Description** Generic function do return the reflect point.

### Examples

```
C.xy=Reflectpoint(A,B);
D.xy=Reflectpoint(A,[[2,3]]);
E.xy=Reflectpoint([-1,1],[[1,0]]);
F.xy=Reflectpoint(A,[C,E]);
Lineplot([C,E],["do"]);
```

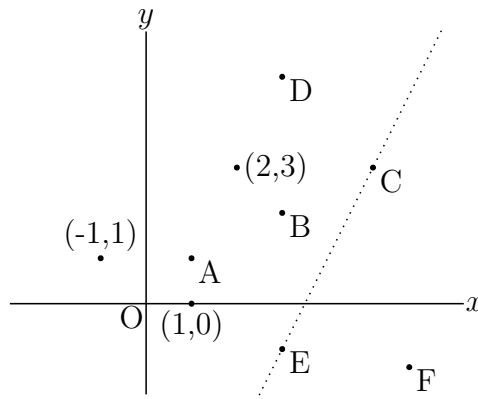

[⇒Command List](#)

## Rotatepoint

**Usage** Rotatepoint(point, angle(degree), center);

**Description** Generic function to rotate a point.

### Examples

```
C.xy=Rotatepoint(A,2*pi/3,B);
D.xy=Rotatepoint((5,2),pi/3,B);
E.xy=Rotatepoint([3,0],-pi/4,A);
```

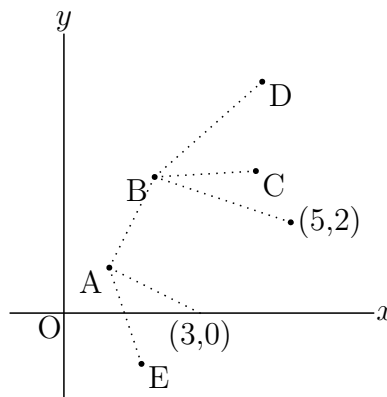

[⇒Command List](#)

## Scalepoint

**Usage** Scalepoint(point, scale, center):

**Description** Generic function to scale a point.

### Examples

```
D.xy=Scalepoint(A,[3,2],[0,0]);
E.xy=Scalepoint(A,[3,2],B);
F.xy=Scalepoint(A,C.xy,[0,0]);
Arrowdata("1",[[0,0],C]);
Pointdata("1",[A,B,C,D,E,F],["size=2"]);
Letter([A,"e2","A("+A.x+", "+A.y+")"]);
Letter([B,"e2","B("+B.x+", "+B.y+")"]);
Letter([C,"e2","C("+C.x+", "+C.y+")"]);
```



```
Letter([D,"e2","D("+D.x+",""+D.y+")]");
Letter([E,"e2","E("+E.x+",""+E.y+")]");
Letter([F,"e2","F("+F.x+",""+F.y+")]");
```

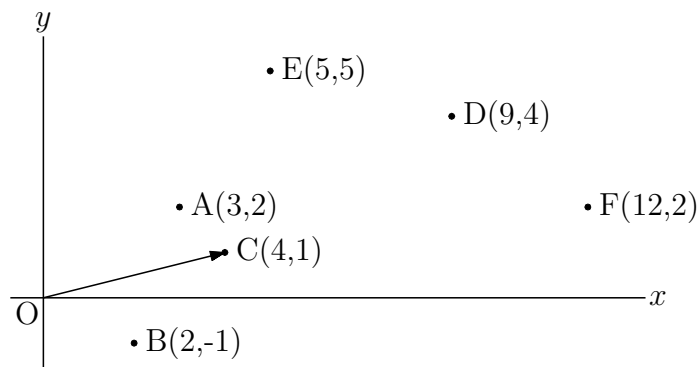

[⇒Command List](#)

## Translatepoint

**Usage** Translatepoint(point, vector);

**Description** Generic function to translate a point.

### Examples

```
C.xy=Translatepoint(A,[2,3]);
D.xy=Translatepoint(A,B.xy);
```

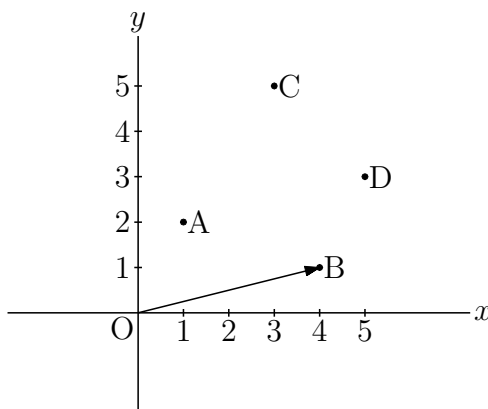

[⇒Command List](#)

## Setarrow

**Usage** Setarrow(size(1), angle(18), position(1), cut(0.2))

**Description** set the style of arrow

[⇒Command List](#)

## Arrowdata

**Usage** Arrowdata(name,[starting point, ending point] , options)

**Description** draw an arrow line between two points.

Options : Those of Setarrow and "Line=n(y)"(with line),"Cutend="(trimming),"Color="

### Examples

```

Arrowdata("1", [A,B]);
Arrowdata("2", [[1,0], [2,3]], [2]);
Arrowdata("3", [[2,0], [3,3]], [3,45]);
Arrowdata("4", [[3,0], [4,3]], [3,1,0.5]);
Arrowdata("5", [[4,0], [5,3]], [3,1,1,0]);
Arrowdata("6", [[5,0], [6,3]], [3,"Line=y"]);
Arrowdata("7", [[6,0], [7,3]], [3,"dr,2"]);
Arrowdata("8", [[7,0], [8,3]], [3,1,1,0.5,"Color=red"]);

```

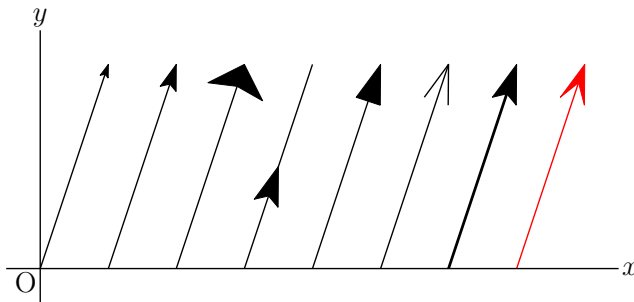

```

Circledata("1", [A,A.xy+[0.5,0]]);
Circledata("2", [B,B.xy+[0.7,0]]);
Arrowdata([A,B], ["Cutend=[0.5,0.7]"]);
Letter([A,"c","A",B,"c","B"]);

```

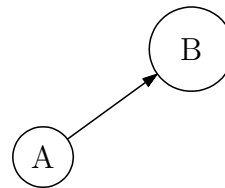

⇒Command List

## Arrowhead

**Usage** (1) Arrowhead(point, direction , options)  
(2) Arrowhead(point/positon ratio, PD(curve), options)

**Description** (1) draw an arrowhead with specified direction at a point.  
(2) draw an arrowhead on a PD(curve)

Options are the same as Arrowdata

Position ratio of a point on the curve is from 0 to 1.

### Examples

Let A=[1,1].

- Arrowhead(A, [-1,1]);
- Arrowhead([1,1], [-1,1], [2,60]);
- Arrowhead(A, [-1,1], [2,30,0.5]);
- Arrowhead([1,1], [-1,1], [2,20,0.5,"Line=y"]);

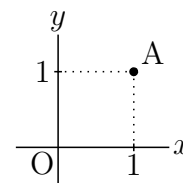

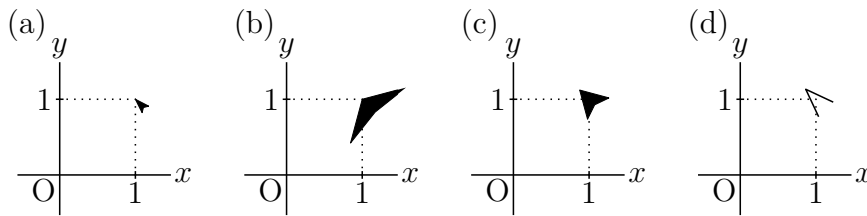

Let A whose position ratio is 0.6 be on the curve cr1.



- (e) `Arrowhead(A,"cr1");`
- (f) `Arrowhead(0.6,"cr1",[2,1,0.5,"Color=red"]);`
- (g) `Arrowhead(1,"cr1");`
- (h) `Arrowhead(1,"Invert(cr1)",["Line=y"]);`

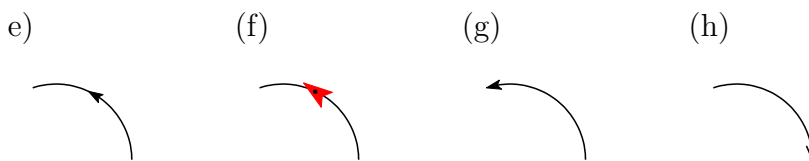

[⇒Command List](#)

## Lineplot

**Usage** `Lineplot(name, [A, B], options)`

**Description** Draw the straight line through the two points A, B.

**Details** The list of two points is given by the coordinates or the geometric elements.  
 If the list of points is given by geometric elements, "name" can be omitted.  
 options : "+" means drawing a half straight line.  
 Both the line type and "+" can be specified as a list.

### Example

Draw a straight line connecting the coordinates.

```
Lineplot("1",[[0,0],[1,2]]);
```

Draw the two points A, B in the Cinderella main screen and draw a straight line AB.

```
Lineplot([A,B]);
```

Some examples of options.

```
Lineplot([A,B],["dr,0.5","+"]); // Draw a half line with A as the end point.
```

```
Lineplot([C,D],["dr,2"]); // Draw the straight line CD with double thickness.
```

```
Lineplot([E,F],["da"]); // Draw the straight line EF as a broken line.
```

```
Lineplot([G,H],["do"]); // Draw the straight line GH as a dotted line.
```

The results are shown in order from the top left of the next figure.

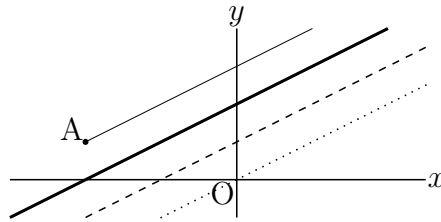

⇒Command List

## Listplot

**Usage** Listplot(name, a list of points, options)

**Description** Connect points by line segments.

**Details** The list of two points is given by the names of the coordinates or the geometric elements.

If the list of points is given by geometric element names, the name of the plotting data can be omitted.

**Example1** Line style

```
Listplot([A,B]);
Listplot([C,D],["dr,2"]);
Listplot([E,F],["da"]);
Listplot([G,H],["da,3,1"]);
Listplot([K,L],["da,1,3"]);
Listplot([M,N],["do"]);
Listplot([O,P],["do,3"]);
Listplot([Q,R],["do,3,3"]);
```

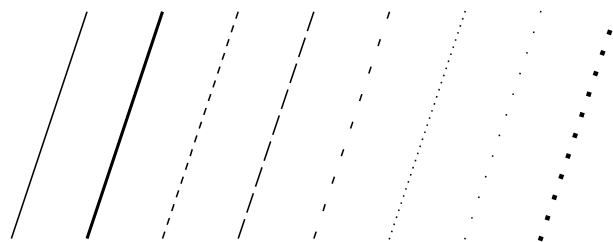
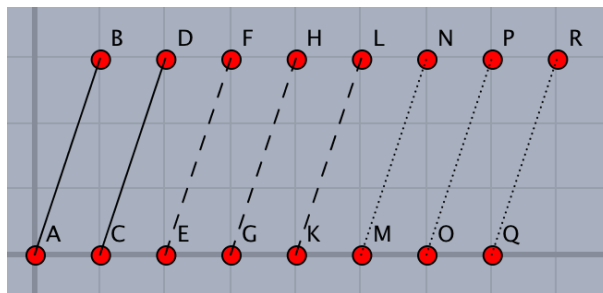

**Example2** Draw a triangle.

Draw the triangle ABC or simply creating 3 points A, B, C with the Euclidean view.

```
Addax(0);
Listplot([A,B,C,A]);
```

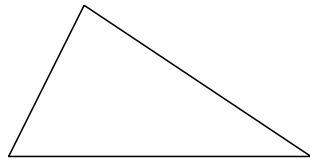

The position of the points can be specified by coordinates. In this case "name" is necessary.

```
Listplot("1", [[0,0], [2,0], [1,2], [0,0]]);
```

**Example3** Expansion of finite Fourier series

$$\frac{\pi}{2} + \sum_{n=0}^{30} \frac{1 - (-1)^n}{n} \sin nx$$

The plotting data is a list of the coordinates of points. Therefore, define the function in Cindyscript as follows, create plotting data pd and pass it as argument.

```
f(x):=(
  s=pi/2;
  repeat(30,n,s=s+(1-(-1)^n)/n*sin(n*x));
);
pd=apply(0..200,t,
  x=-2*pi+t*4*pi/200;
  [x,f(x)];
);
Listplot("1",pd);
Expr([[ -2*pi,-0.5], "s", "-2\pi", [-pi,-0.5], "s", "-\pi", [pi,-0.5], "s",
  "\pi", [2*pi,-0.5], "s", "2\pi", [0,pi], "w2", "\pi"]);
```

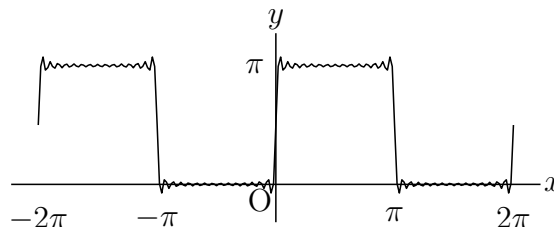

There is a limit on the length of the list, so it is impossible to use a long list or to use it many times. For example, in the Shellpinski gasket using Turtle Graphics, the next size is possible, but in the growth model of plants there are many branches so it can not be a big figure. We devise a script and divide it into lists of about 200.

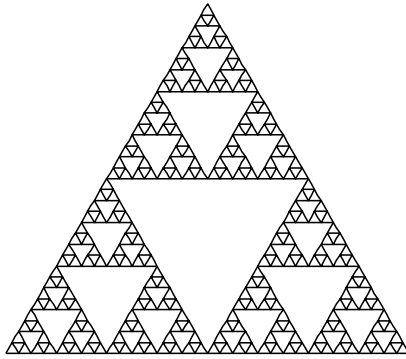

[⇒Command List](#)

## Mksegments

**Usage** Mksegments()

**Description** Create plotting data of all geometric segments.

**Details** All the line segments drawn by the "Add line segment" tool in the Euclidean view are used as plotting data as they are. For example, if the line segment AB is created, plotting data `sgAB` is created. After that, if you change the identification name of point B (for example to Q) in the inspector of the Euclidean view, the plotting data name is also changed. Even if the line segmen has already been drawn, it can be changed.

**Example** Examples of geometric progression

Draw a figure of a geometric progression that makes triangles by connecting the midpoints of each edge of a triangle one after another.

First draw the triangle ABC with the "Add line segment" tool in the Euclidean view.

Take the midpoint of each edge with the "Add midpoint" tool in the Euclidean view and connect the midpoints with the "Add line segment" tool in the Euclidean view.

Repeat this process. If you write `Mksegments()`;, you can obtain the data of the figure at the completion of drawing, without writing `Listplot ([A, B, C])`;

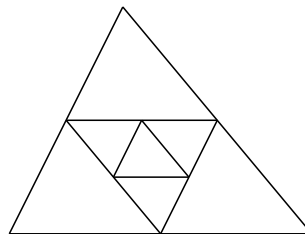
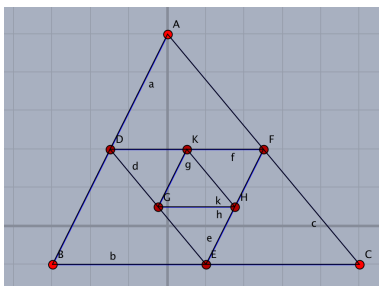

[⇒Command List](#)

## Framedata

**Usage** Framedata(name,expr,options)

**Description** Generic function to draw a rectangle.

**Details** expr type1 : [center,lx,ly] : lx and ly are a half of the horizontal and vertical length.

expr type2 : [p1, p2] : if p1 and p2 are name of point, 1st argument can be omitted.

options : usual options and "center"/"corner" (type2).

If "center", p1 is center, p2 is apex of rectangle. (Default)

If "corner", p1 and p2 are diagonal point of rectangle.

### Examples

```
Framedata("1"); // same as Framedata([SW,NE],["corner"]);
Framedata("2", [[0,0],2,2]);
Framedata("3", [A,1.5,1.2]); // left figure
Framedata([B,C]); // center figure
Framedata([D,E],["corner"]); // right figure
```

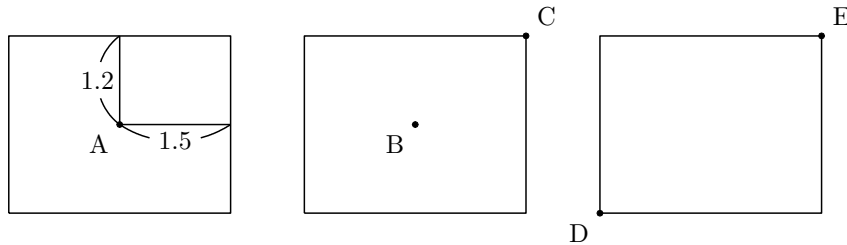

**Reference** [Ovaldata](#).

[⇒Command List](#)

## Polygonplot

**Usage** Polygonplot(name, point list, integer, options)

**Description** Generic function to draw a polygon inscribed inside the circle.

**Details** If the point list is [A,B] then the center is A and the radius is AB for the circle.

Corresponding circle is not drawing. Two points A,B allowed to be coordinates.

option : If A and B are geometric point , make geometric apex by "Geo=y".

### Examples

```
Addax(0);
Polygonplot("1", [[-4,1],[-4,3]],7);
Polygonplot("2", [A,B],7);
Polygonplot("3", [C,D],7,["Geo=y"]);
```

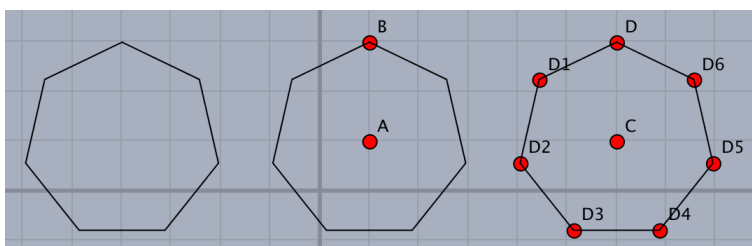

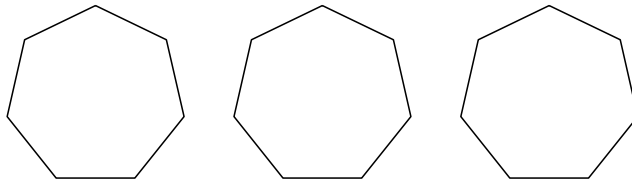

We can draw the regular polygon whose one side is the line segment AB.

```
n=5;
pti=[complex(A),complex(B)];
th=2*pi/n;
repeat(n-2,s,
  z1=pti_s;
  z2=pti_(s+1);
  z=z2+(z2-z1)*(cos(th)+i*sin(th));
  pti=append(pti,z);
);
pt=apply(pti,gauss(#));
pt=append(pt,A.xy);
Listplot("1",pt);
```

pti is the list of complex numbers correspond to each vertex, pt is the list of coordinates of vertexes.

[⇒Command List](#)

### 1.2.3 Curved line

## Bezier

**Usage** Bezier(name,nodes of curve, control points, options)

**Description** Draw a bezier curve.

For each interval, control points are given in two lists for 3rd-order and one list for 2nd-order Bezier curve.

You can specify the number of division among nodes (default value is 10).

### Examples

2nd-order Bezier curve  
Bezier("1", [A,B], [C]);

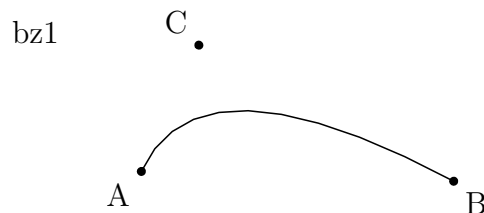

3rd-order Bezier curve  
Bezier("c", [A,B], [C,D]);

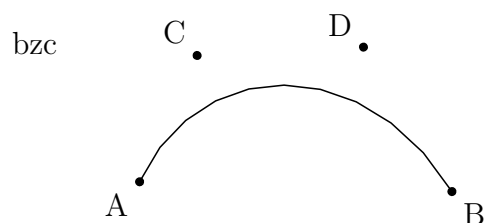



Connecting two curves,  
`Bezier("3", [A,B,C], [[D],[E,F]]);`

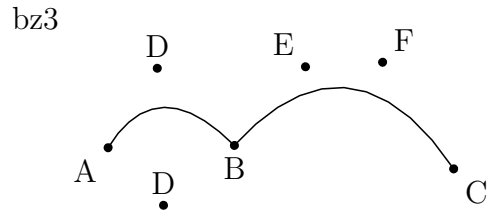

If D,B,E are on the straight line,  
the curve becomes smoothly.  
`Bezier("S", [A,B,C], [[D],[E,F]]);`

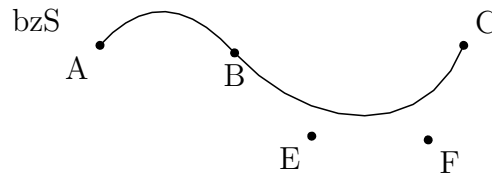

`Bezier("name", [A,B,C,D], [E,F,G,H,K,L]);`

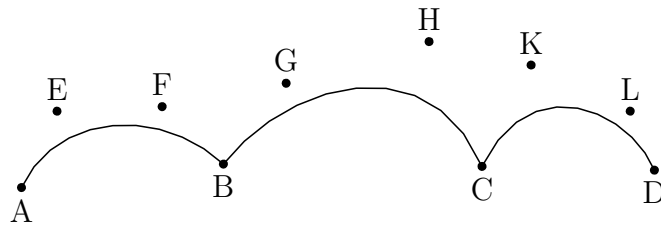

`Bezier("1a", [A,B,C], [[D],[E,F]], ["Num=3"]);`

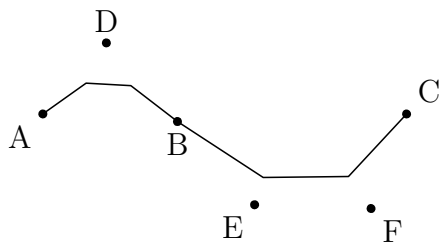

`Bezier("d5e", [A,B,C], [[D],[E,F]], ["Num=200", "da"]);`

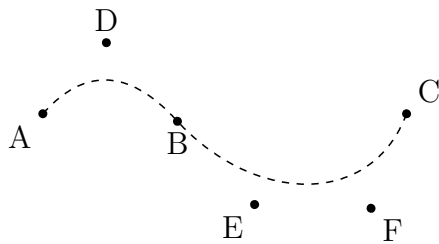

`Bezier("1", [A,B,C,D], [E,F,G,H,K,L], ["Num=[2,3,4]"]);`

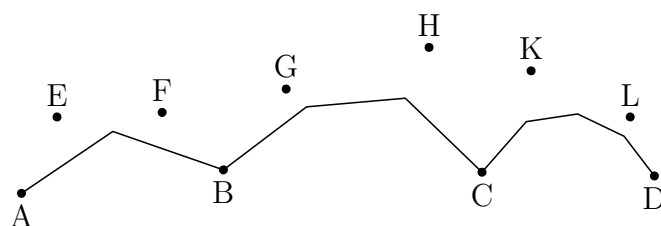

## Beziersmooth

**Usage** Beziersmooth(name, a list of nodes, options);

**Description** Generic function to draw a smooth Bézier curve.

**Details** Control points are added to keep smoothness.

### Examples

```
Beziersmooth("1", [A,B,C,D]);
```

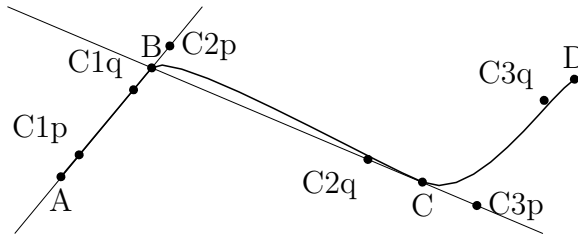

**Remark** Control points are movable.

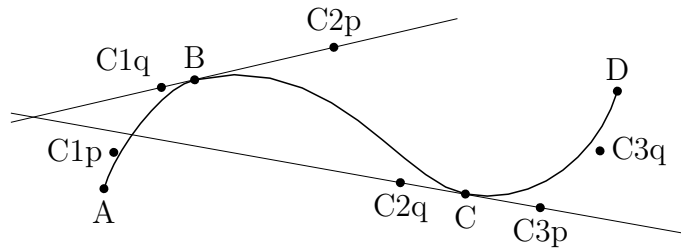

## Beziersym

**Usage** Beziersym(name, a list of nodes, options);

**Description** Generic function to draw a smooth Bézier curve.

**Details** Control points are added to be symmetric with respect to each node.

### Examples

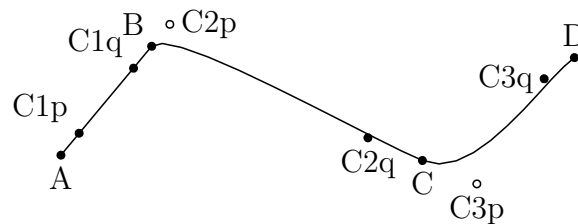

**Remark** Some control points are movable.

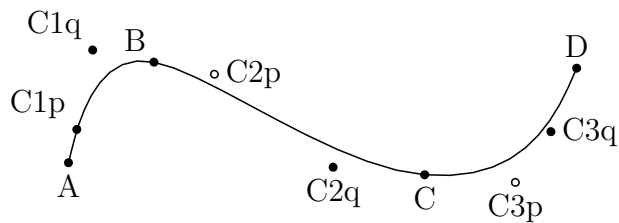

[⇒Command List](#)

## Mkbeziercrv

**Usage** Mkbeziercrv(name, [nodes, control points], options)

**Description** Draw some Bézier curves.

**Details** In the case of a single Bézier curve, [ ] outside the list can be omitted.

Mkbeziercrv(name, [nodes, control points], options) is same as Bezier(name, [nodes, control points], options).

Mkbeziercrv("n", [[A,B,C], [[D], [E,F]]]) is same as Bezier("n", [A,B,C], [[D], [E,F]]). The name of the plotting data is "bz".

### Example1

```
Mkbeziercrv("5", [[[A,B,C], [[D], [E,F]]], [[G,H,K,L], [[M], [N,O], [P]]]]);
```

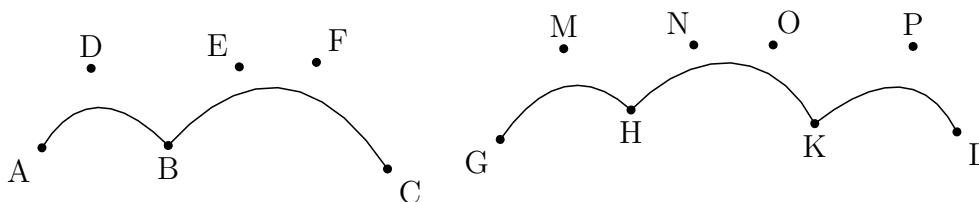

[⇒Command List](#)

## Mkbezierptcrv

**Usage** Mkbezierptcrv(a list of points, options)

**Description** Draw a Bézier curve.

**Details** Arrange the control points automatically. After that, move the nodes and the control points and correct the Bézier curve to what you want to draw.

In the case of multiple curves, [ ptlist1, ptlist2.... ]

The name is automatically attached in order from A.

The options are as follows:

"Deg=..." You can specify the degree (Default is 3rd order).

"Num=..." You can specify the partition number (the partition point number - 1) for each section (Default is 10).

## Example

```
Mkbezierptcrv([A,B,C]);
```

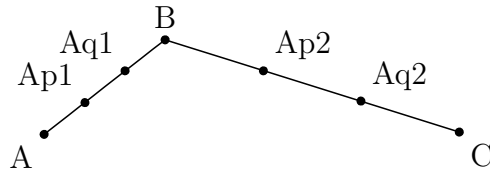

After that, move the nodes and the control points and correct the Bézier curve to what you want to draw.

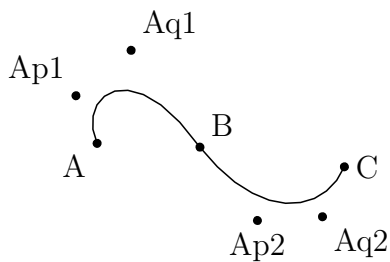

```
Mkbezierptcrv([A,B,C],["Deg=2"]);
```

If Deg = 2, it is the Bézier curve of 2nd order.

One control point can be set for each section.

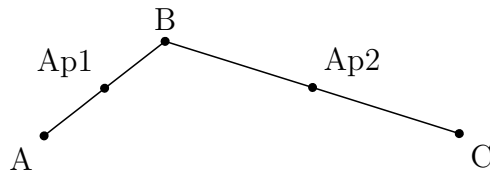

In the case of multiple curves, [ ptlist1, ptlist2.... ]

```
Mkbezierptcrv([[A,B,C],[D,E,F,G]]);
```

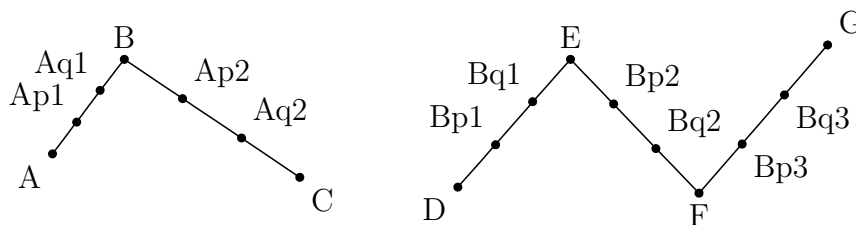

[⇒Command List](#)

## Bspline

**Usage** B spline(name ,list of control points, options)

**Description** Draw second degree B-spline curve.

**Details** Though not displayed, nodal points are calculated automatically.

### Examples

```
B spline("1", [A,B,C,D,E]); (=Bezier("1", [A, (B+C)/2, (C+D)/2, E], [B,C,D]);)
```

The name becomes bz b1 instead of bz1. Endpoints can be moved instead of control points.

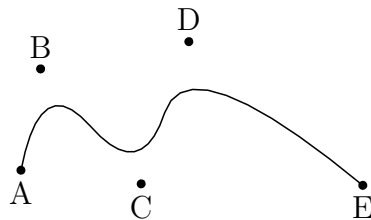

```
B spline("1", [A,B,C,D,A]);
```

The generated curve becomes closed when the first component of the list is the same as the last one.

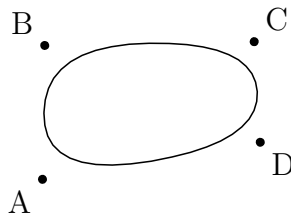

[⇒Command List](#)

## CRspline

**Usage** CRspline(name, list of node points, options)

**Description** Draw single Catmull-Rom spline curve.

**Details** Only node points are free and control points cannot be moved.

Extra options is :

"size->" specifies the thickness of line on the Euclidean view.

### Examples

```
CRspline("1", [A,B,C,D]);
```

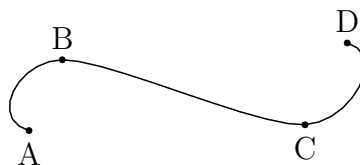

[⇒Command List](#)

## Ospline

**Usage**      `Ospline(name, a list of control points, options);`

**Description**    Generic function to draw a spline curve of Oshima.

### Examples

```
Ospline("1", [A,B,C,D,E]);
```

```
Ospline("1", [A,B,C,D,A]);
```

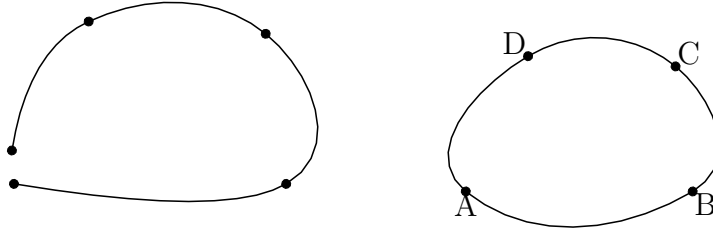

**Reference**      [Bspline](#).

[⇒Command List](#)

## Circledata

**Usage**      `Circledata(name, list, options)`

**Description**    Draw a circle or polygon.

**Details**      The list consists of the central point and some point on the circle or the radius. It is also permitted that three points on the circle are given in the list. The name can be omitted when the central point and a point on the circle are given with the names of their geometric components.

Options :

"Rng= $[\theta_1, \theta_2]$ " specifies the range of argument in which the circle is drawn.

"Num=number of division" specifies the number of dividing points used to draw circle.

When this number is small, the corresponding polygon is drawn.

### Examples

The circle with center `[0,0]` or `A` and radius 2 ( draw `A` by drawing tool)

```
Circledata("1", [[0,0], [2,0]]);(or [[0,0], 2])
```

```
Circledata("1", [A,A+[2,0]]);(or [A,2])
```

The circle with center `A` and radius `AB`

```
Circledata([A,B]);
```

The circle which passes through three points `A`, `B`, and `C`

```
Circledata([A,B,C]);
```

When we use `Circledata([A,B,C])`, the central point of the circle can be drawn by the following command.

```
Pointdata("1", [crABCcenter]);
```

When we add options "dr,2", "da", "do", the following figures are generated respectively.

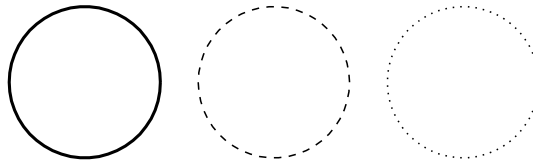

The circular arc with center A, radius AB, and the range of argument  $\left[0, \frac{\pi}{3}\right]$

```
Circledata([A,B], ["Rng=[0,pi/3]"]);
```

The sector.

Draw A, B, C by drawing tool.

```
th=arctan2(B-A);
C.xy=Rotatepoint(B,pi/3,A);
Circledata([A,B], [Assign("Rng=[th,th+pi/3]", ["th",th])]);
Listplot([B,A,C]);
Letter([A,"s","A",B,"e","B",C,"nw","C"]);
```

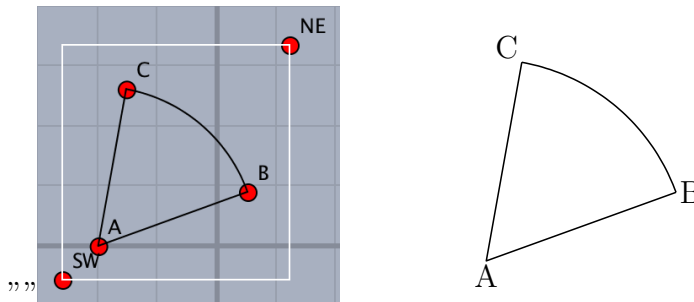

The circle with center A and radius AB, together with the inscribed equilateral hexagon (left figure)

```
Circledata("1", [A,B]);
Circledata("2", [A,B], ["Num=6"]);
```

The position of vertices can be changed via the option "Rng=". (right figure)

```
Circledata("2", [A,B], ["Num=6", "Rng=[pi/6,13/6*pi]"]);
```

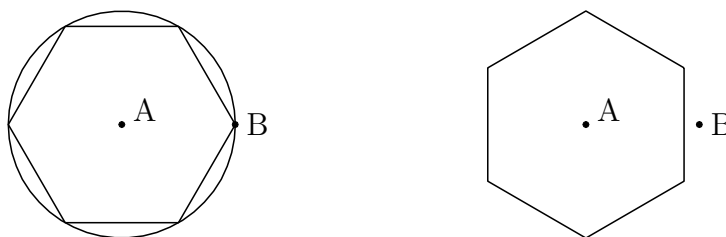

## Mkcircles

**Usage** Mkcircles()

**Description** Create plotting data of all geometric circles.

**Details** All circles drawn by the "add circle" tool (any one of three types) in the Euclidean view are used as plotting data as they are. For example, if you create a circle with the center A and the point on the circumference as B, the plotting data `crAB` is created. After that, if you change the identification name of point B (for example to Q) in the inspector of the Euclidean view, the geometric point name is also changed. Even if the circle has already been drawn, it can be changed.

⇒Command List

## Ellipseplot

**Usage** Ellipseplot(name, [F1,F2,A/a], range, options)

**Description** Generic function to draw ellipse.

### Examples

F1,F2 are focus points, A is a point on the ellipse, a is the length F1-A-F2.  
Default of the range is [-5,5].

### Examples

```
Ellipseplot("1", [A,B,4]);           //sum of distance from Focus is 4.
Ellipseplot("1", [A,B,C], "[0,pi]"); //half of ellipse.
```

Now draw tangent and normal. Draw figures by draw tool on Euclidean view. Put point D on tangent and E on normal.

```
Ellipseplot("1", [A,B,C]);
Lineplot([C,D]);
Lineplot([C,E]);
Arrowdata([A,C]);
Arrowdata([C,B]);
Anglemark([A,C,B]);
Expr([A,"s2","F_1",B,"s2","F_2"]);
```

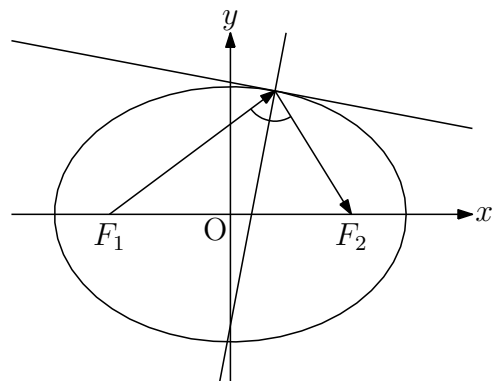
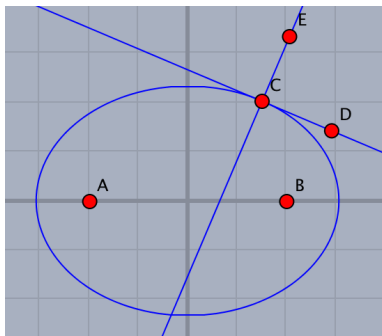



Now draw point D and E on ellipse.

```
Ellipseplot("1", [A,B,C]);  
Listplot([A,C,B]);  
Listplot([A,D,B]);  
Listplot([A,E,B]);  
Expr([A,"s2","F_1",B,"s2","F_2"]);
```

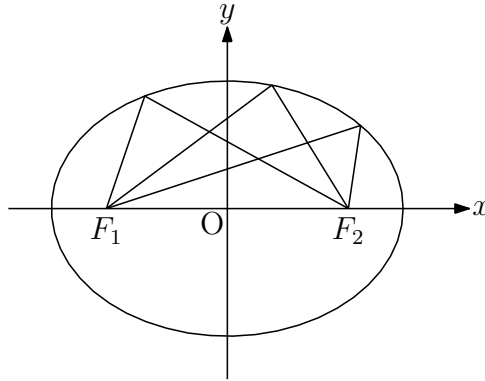

[⇒Command List](#)

## Hyperbolaplot

**Usage** Hyperbolaplot(name,[F1,F2,A], range, options)

**Description** Generic function to draw a hyperbola.

**Details** Option is as usual except "Asy=line style".This option is for drawing asymptotes.

**Reference** [Ellipseplot](#) and [Parabolaplot](#).

### Examples

```
Hyperbolaplot("1", [A,B,C]);  
Hyperbolaplot("1", [A,B,2]);  
Hyperbolaplot("1", [A,B,C], ["Asy=do"]);
```

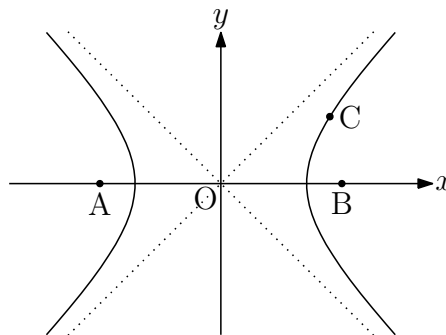

[⇒Command List](#)

## Parabolaplot

**Usage** Parabolaplot(name, [A, B, C], range, options);

**Description** Generic function to draws a parabola.

**Details** A is the focus point, BC is the directrix. Default of the range is  $[-5, 5]$ .

### Examples

```
Parabolaplot("1", [A,B,C]);  
Parabolaplot("1", [A,B,C], "[-4,4]"); //range is [-4,4]  
Parabolaplot("1", [[0,1], [-1,-1], [1,-1]]); // coordinate
```

Area enclosed by parabola and tangent

```
Parabolaplot("1", [A,B,C]);  
Putoncurve("D", "gr1para");  
Putoncurve("E", "gr1para");  
Tangentplot("1", "gr1para", "x="+D.x);  
Tangentplot("2", "gr1para", "x="+E.x);  
pts=Intersectcurves("lntn1", "lntn2");  
Listplot("1", [E,pts_1,D]);  
Hatchdata("1", ["ii"], [{"gr1para", "s"}, {"sg1", "n"}]);
```

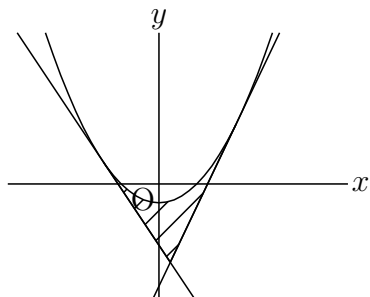

[⇒Command List](#)

## Ovaldata

**Usage** Ovaldata(name, [A, B], options);

**Description** Generic function to draw a rectangle with rounded corners.

**Details** A is the center, B is a diagonal point.

option : ratio of the roundness ( default is 0.2) .

### Examples

```
Ovaldata("1", [A,B]);  
Ovaldata("2", [C,D], [0]);  
Ovaldata("3", [E,F], [1, "dr,3"]);  
Ovaldata("4", [G,H], [1.5, "da"]);
```

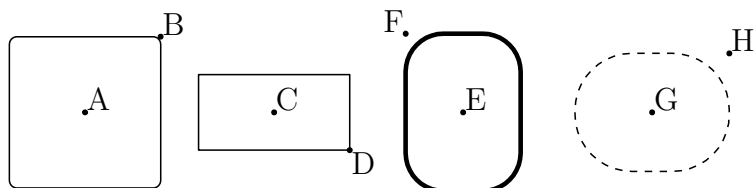

[⇒Command List](#)

## 1.2.4 Graph of function

### Plotdata

**Usage** Plotdata(name, function, variable and range, options)

**Description** Generic function to draw the graph of function.

**Details** Options : next options and usual options.

”Dis=real number”: discontinuity

”Exc=list of real numbers”: exclusion points

”Exc=function”: exclude the zero points of the function

### Examples

```
Plotdata("1", "x^2-2*x", "x");
```

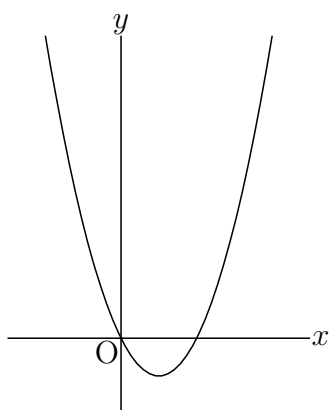

Draw in red.

```
Plotdata("1", "x^2-2*x", "x", ["Color=[1,0,0]"]);
```

```
Plotdata("3", "2*sin(2*x-pi/4)", "x=[0,2*pi]");
```

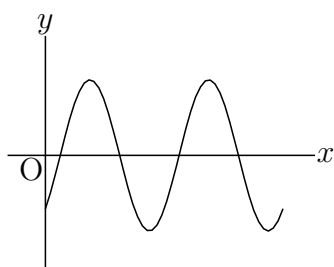

```
Plotdata("1", "sin(x)", "x", ["do"]);
```

```
Plotdata("2", "sin(x)+1", "x", ["da"]);
```

```
Plotdata("3", "sin(x)+2", "x", ["dr,2"]);
```

```
Plotdata("4", "sin(x)+3", "x");
```

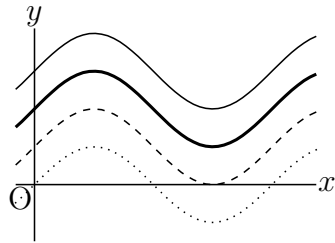

Draw smoothly by "Num=n" option.

Left figure: "Num=50"(default), Right figure: "Num=200"

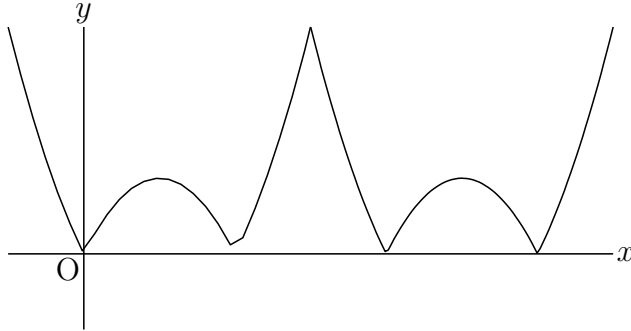

Draw discontinuity accurately by "Dis" option.

```
Plotdata("1","tan(x)","x",["Num=200"]); // left figure
Plotdata("1","tan(x)","x",["Num=200","Dis=50"]); // right figure
```

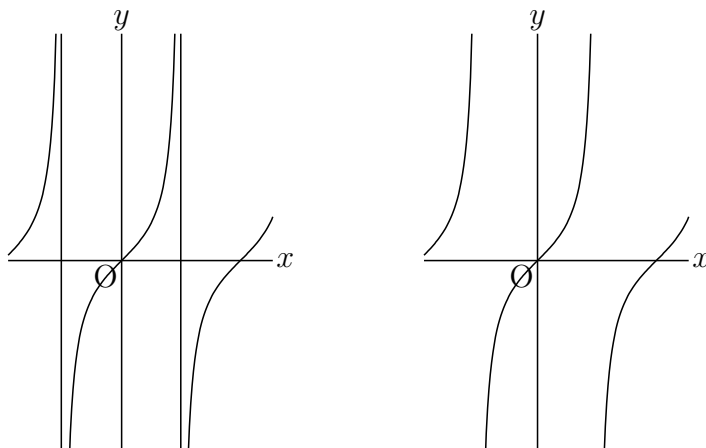

Draw floor function.

```
Plotdata("1","floor(x)","x",["Num=100","Dis=0.9"]);
Drwxy();
repeat(7,s,start -> -2,
  Pointdata(text(s+3),[s+1,s],["Inside=0","Size=3"]);
);
```

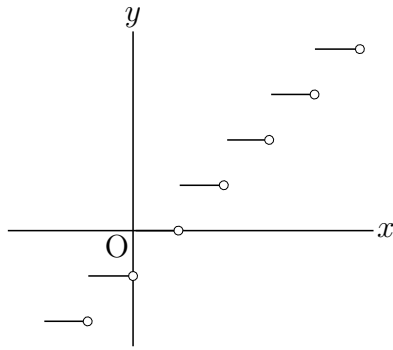

Assign a value to the letter "b".

```
repeat(50,t,
  cb=t/5-5;
  Plotdata(text(t),Assign("b*x-b^2","b",cb),"x");
);
```

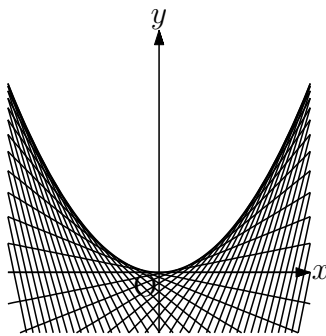

[⇒Command List](#)

## Implicitplot

**Usage**      `Implicitplot(name,functionstring,range of x, range of y, options);`

**Usage**      Generic function to draw the graph of a implicit function.

### Examples

```
Implicitplot("1","x^2-x*y+2*y^2=4","x=[-3,3]","y=[-2,2]");
```

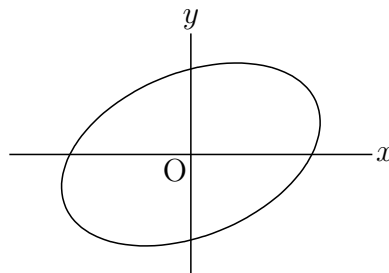

```
Implicitplot("1","x^2+2*y^2=4","x=[-2,2]","y=[-2,2]");
Hatchdata("1",["i"],[["imp1"]]);
```

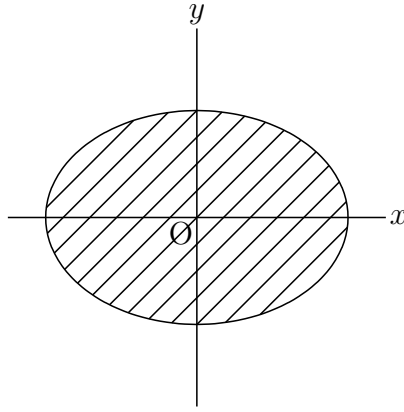

[⇒Command List](#)

## Deqplot

**Usage** Deqplot(name, expression, names of variations, options)

**Description** Draw the solution curve of a differential equation.

**Details** The differential equation and its initial conditions should be specified as arguments.

### Examples

The solution curve of the equation  $y'' = -y$  with initial conditions  $y(0) = 1, y'(0) = 0$

```
Deqplot("1", "y`=-y", "x", 0, [1,0]);
```

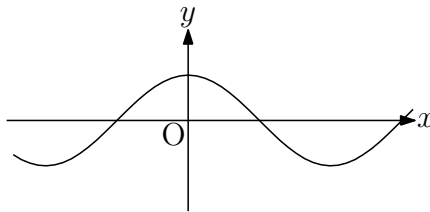

**Remark** Derivative symbol  $y'$  is a backquote, not a single quote.

The solution curve of the equation  $y' = y * (1 - y)$  with initial condition  $y(0) = 0.5$

```
Deqplot("2", "y`=y*(1-y)", "x", 0, 0.5, ["Num=100"]);
```

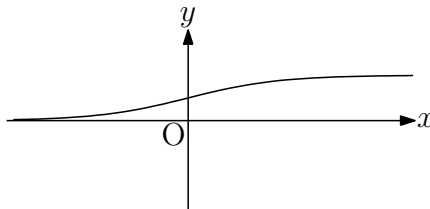

The solution curve of the equation  $[x, y]' = [x(1 - y), 0.3y(x - 1)]$  of variable  $t$  with initial conditions  $x(0) = 1, y(0) = 0.5$

```
Deqplot("3", "[x,y]`=[x*(1-y),0.3*y*(x-1)]", "t=[0,20]", [1,0.5], ["Num=200"]);
```

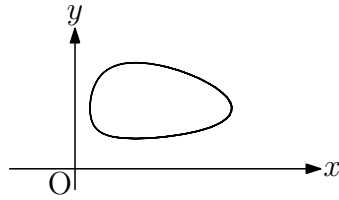

[⇒Command List](#)

## Paramplot

**Usage** Paramplot(name, expression, variable and domain, options);

**Description** Generic function to draw a curve of parametric representation.

### Examples

Draw a cycloid curve.

```
Paramplot("1", "[t-sin(t), 1-cos(t)]", "t=[0,2*pi]");
```

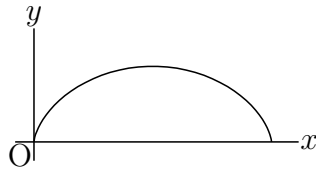

Draw ellipses with options.

```
Paramplot("1", "[2*cos(t)-5, sin(t)]", "t=[0,2*pi]");
Paramplot("2", "[2*cos(t), sin(t)]", "t=[0,2*pi]", ["dr,2"]);
Paramplot("3", "[2*cos(t)+5, sin(t)]", "t=[0,2*pi]", ["da"]);
Paramplot("4", "[2*cos(t)+10, sin(t)]", "t=[0,2*pi]", ["do"]);
```

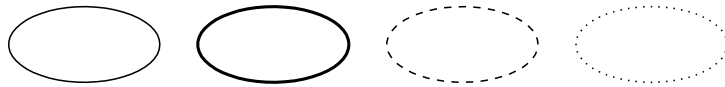

[⇒Command List](#)

## Polarplot

**Usage** Polarplot(name, expression, variable and domain, options);

**Description** This function draws a curve of polar equation.

**Examples** To draw a cardioid.

```
Polarplot("1", "2*(1+cos(t))", "t=[0,2*pi]", ["Num=200"]);
```

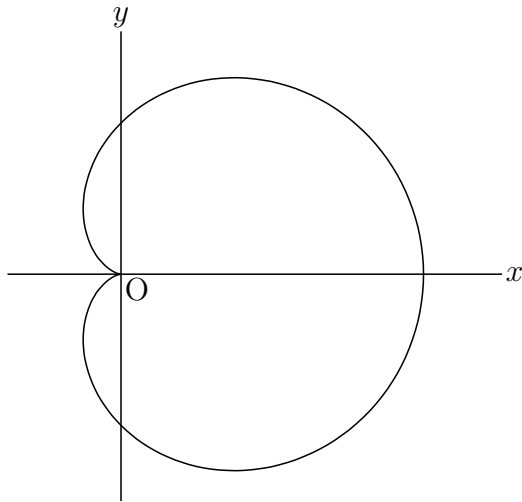

[⇒Command List](#)

## Periodfun

**Usage**            Periodfun(defL,repeat,options)

**Description**    Function to draw the graph of a periodic function.

**Details**            defL is a list of fun(str),interval,division number.

The options are "Con=n/do, Color=name" for discontinuous parts.

ex. "Con=do,Color=red" , " Con=n". Default is broken line and draw.

Repeat count is a count number or a list of count numbers of left side and right side.

The return value are a list of function in Maxima format and the period.

**Remark**            The functions should be defined on the symmetrical interval [-a,a].

### Examples

```
defL=["0", [-1,0], 1, "1", [0,1], 1];
Periodfun(defL, 2, ["dr,2"]);
memori=apply(-5..5,x,[x,text(x)]);
memori=flatten(remove(memori,[[0,"0"]]));
Htickmark(memori);
Vtickmark([1,"1"]);
```

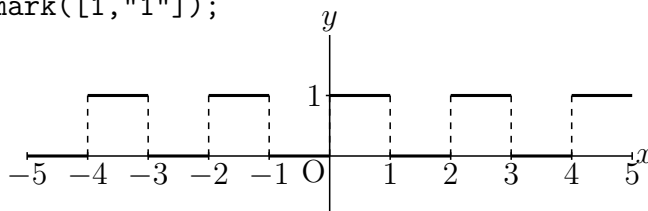

```
defL=["0", [-1,0], 1, "x^2", [0,1], 50];
Periodfun(defL, 2, ["Con=n", "dr,2"]);
memori=apply(-5..5,x,[x,text(x)]);
memori=flatten(remove(memori,[[0,"0"]]));
Htickmark(memori);
Vtickmark([1,"1"]);
```



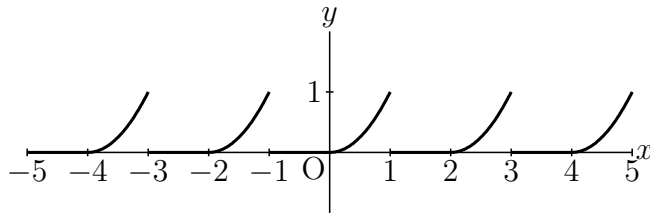

[⇒Command List](#)

## Fourierseries

**Usage**           Fourierseries(name,coeff,period,terms)

**Description**   Function to draw the graph of a fourier series.

**Details**            $a_0 + \sum_{n=1}^{\infty} (a_n \cos nx + b_n \sin nx)$

coeff is a list of  $[a_0, a_n, b_n]$ . Each element are string.  
term is a number of terms.

### Examples

```
Fourierseries("1",["1/2","0y","(1-(-1)^n)/(pi*n)"],2,6,["Num=200"]);
```

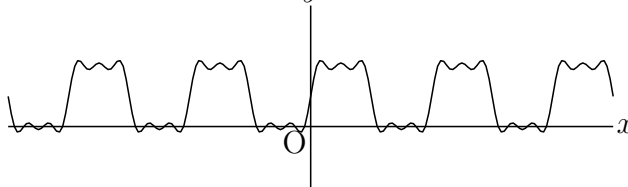

[⇒Command List](#)

## Tangentplot

**Usage**           Tangentplot(name,PD, pointinfo, options);

**Description**   Generic funtion to draw a tangent line of a plotting data.

**Details**           The pointinfo is one of "x=xvalue", "y=yvalue", [point, parameter].  
The option "nth" is used to set the number when plotting data has multi intersects.

### Examples

```
Plotdata(`"1","x^2","x")
Tangentplot("1","gr1","x=2");
Tangentplot("2","gr1","y=1",["Color=red"]);
Tangentplot("3","gr1","y=1",[2,"Color=blue"])
```

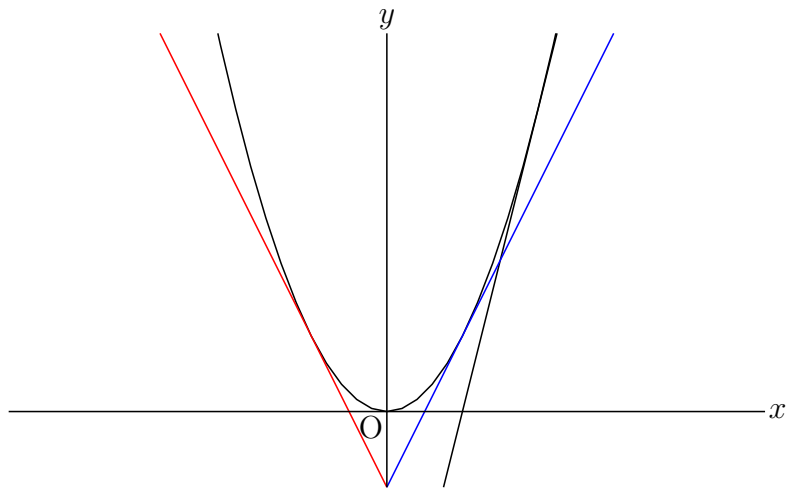

**Reference**     [Derivative.](#)

[⇒Command List](#)

### 1.2.5 Letter

#### Letter

**Usage**            Letter([position, direction, string],options)

**Description**    Display the string.

**Details**            Write the string at the position specified by position (or coordinates) and direction.

The position (or coordinates) can also be specified by the geometric point name.

The direction is "e", "w", "n", "s", "c". The distance from the specified position can also be given as a numerical value. For example, "e2" and "e3" are placed twice and three times of the slightly unit distance away from "e", respectively.

Multiple strings can be passed in the form of a list.

**Remark**            The derivative symbol ' uses \$ ' \$ (single quart) in mathematical mode (interleaved with two \$ s). Option is size of font. For example, ["size=32"]

#### Example

```
Letter([[2,1] , "se", "P"]); // Display P in the southeast of the coordinates (2, 1).
Letter([C , "c", "C"]); // Display C with the point C as the center.
Letter([A, "sw", "A", E, "s", "$ f(x)=\frac{1}{4} x^2 $"]);
//Display A in the southwest of point A and  $f(x) = \frac{1}{4}x^2$  in the south of the point E.
```

[⇒Command List](#)

#### Letterrot

**Usage**            Letterrot([pos, dir, move, string])

**Description**    Rotate a string and display it.

**Details** At the position of the coordinates, rotate to the direction specified by the direction vector and write the string.

The third argument is a minute movement amount and can be abbreviated.

### Example

```
Letterrot(C,B-A,"t2n5","AB");
```

It is also possible to write as follows, abbreviated for the amount of movement.

```
Letterrot(C,B-A,"AB");
```

**Reference** [Exprrot](#).

[⇒Command List](#)

## Expr

**Usage** Expr([pos, dir, string]);

**Description** Generic function to write an expression in  $\text{T}_{\text{E}}\text{X}$ style.

**Details** pos : position  
 dir : direction(e,w,s,n,ne,nw,se,sw,c)  
 string : expression

Also see [Letter](#)

### Examples

```
Expr([-3,3],"e","f(x)=\frac{1}{4}x^2");
```

```
Expr([3,1.5],"s2e2","f'(x)=\frac{1}{2}x",[2,0],"s","2",[0,1],"w","1");
```

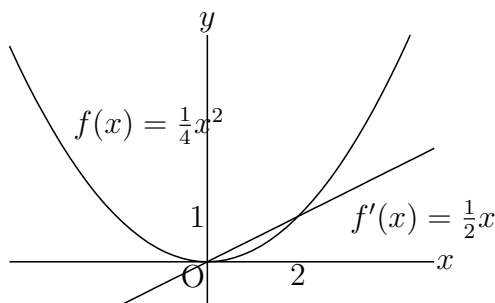

```
Arrowdata(Q,P);
```

```
Expr([Q,"ne2","\displaystyle\int_a^b \log x\,dx="
+text(L.x*(log(L.x)-1)-G.x*(log(G.x)-1))]);
```

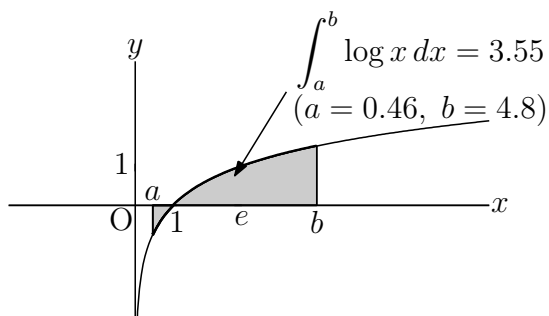

## Exprrot

**Usage** Exprrot([pos, dir,[move(optional)], string);

**Description** Generic function to write a rotated expression in  $\text{T}_{\text{E}}\text{X}$ style.

**Details**

- pos : position : coordinate or name
- dir : direction vector : coordinate or name
- move: "t":tangent , "n":normal
- string : expression

### Examples

```
Exprrot(C,B-A,"\frac{2}{3}");
Exprrot([3,2],[2,-1],"t0n1","\sqrt{3}");
```

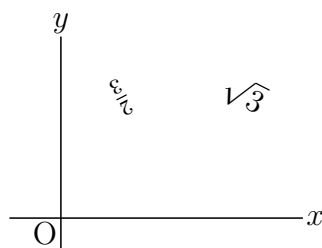
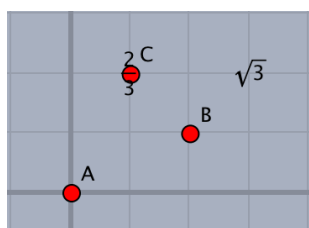

### 1.2.6 Marking

## Anglemark

**Usage** Anglemark( a list of points, options);

**Description** draw an angle mark with an arc at the angle determined by [A,B,C]

Options :

- numerical value size of mark (default is 1)

- draw text "Expr=n, str" or "Let=n, str"

### Examples

draw an angle mark at interior angles of a triangle, write characters.

```
Listplot([A,B,C,A]);
Letter([A,"n1","A",B,"w1","B",C,"e1","C"]);
Anglemark([B,A,C]);
Anglemark([C,B,A],["Expr=\theta"]);
Anglemark([A,C,B],[2,"dr,3","Expr=2,\alpha"]);
```

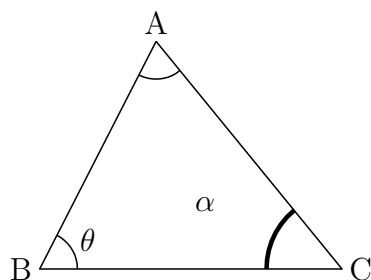

draw  $\circ$  at interior angles of a triangle.

```
Listplot([A,B,C,A]);
Letter([A,"n1","A",B,"w1","B",C,"e1","C"]);
Anglemark([C,B,A],["Expr=\circ","nodisp"]);
```

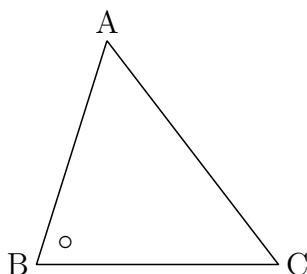

Remark You can draw an angle mark with a parallelogram. Refer to [Paramark](#) .

[⇒Command List](#)

## Paramark

**Usage** Paramark([A, B, C], options);

**Description** Generic function to draw an angle mark with a parallelogram at the angle determined by [A,B,C].

Options : numerical value size of mark (default is 1) and usual options.

**Examples** Draw an angle mark at interior angles of a triangle, write characters.

```
Listplot([A,B,C,A]);
Paramark([A,B,C]);
Paramark([C,A,B],[3,"Expr=\alpha"]);
Paramark([B,C,A],["dr,2","Expr=2,\theta"]);
```

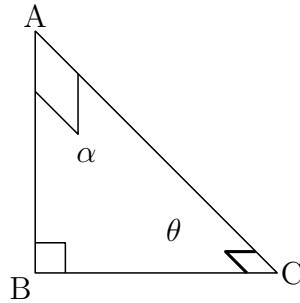

Reference [Anglemark](#).

[⇒Command List](#)

## Bowdata

**Usage** Bowdata(a list of points, options);

**Description** draw the shape of bow connecting two points in the list counterclockwise

**Details** Options :

curvature (default is 1)

size of the blank space in the middle of bow

expression located at the blank space "Expr=expressions"

The location of expressions can be modified via "Expr=t(num)n(num),expressions"

where **t** specifies the movement in the direction of segment and **n** specifies that of normal direction. Both positive and negative numbers are permitted.

line type "dr,n" , "da,m,n" , "do,m,n"

Adding **r** to **tn** results in the turning round.

## Examples

draw the shapes of bow along with the edges of triangle ABC and add marks.

```
Listplot([A,B,C,A]);
Letter([A,"n1","A",B,"w1","B",C,"e1","C"]);
Bowdata([A,B]);
Bowdata([B,C],[1,"Expr=t0n3,a"]);
Bowdata([C,A],[2,1.2,"Expr=10","da"]);
```

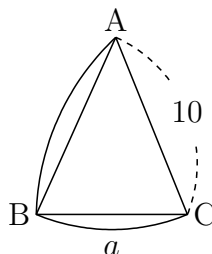

Expressions can be displayed in rotated manner via "Exprrot=tn,expressions" though the Euclidean view does not correspond to this modification.

## Examples

```
Bowdata([B,A],[1,1,"Exprrot=a"]);
Bowdata([D,C],[1,1,"Exprrot=t3n0,a"]);
Bowdata([F,E],[1,1,"Exprrot=t-3n0,a"]);
Bowdata([H,G],[1,1,"Exprrot=t0n3,a"]);
Bowdata([L,K],[1,1,"Exprrot=t0n0r,a"]);
Bowdata([N,M],[1,1,"Exprrot=t3n0r,a"]);
```

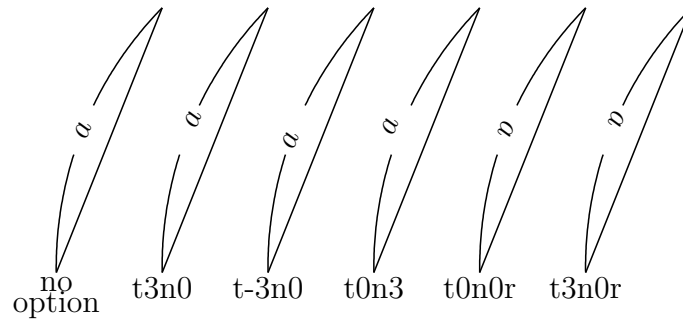

[⇒Command List](#)

## Segmark

**Usage** Segmark(name, list, options)

**Description** Add a mark to a segment.

**Details** Options :

"Type=seg(*n*),cir,poly(*n*)" specifies the kind of mark.

"Width=" specifies the distance between segments of the mark.

"Size=" specifies the size of the mark.

## Examples

```
Listplot([A,B,C,D,A]);
Segmark("1",[A,B],[ "Type=seg,1"]);
Segmark("2",[B,C],[ "Type=seg,2","Width=1.2"]);
Segmark("3",[C,D],[ "Type=cir"]);
Segmark("4",[D,A],[ "Type=poly,4","Size=1.5"]);
```

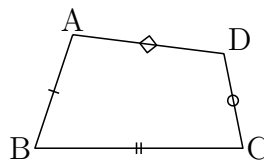

[⇒Command List](#)

## Htickmark

**Usage** Htickmark([x-coord,[direction(optional)],expression,...]);

**Description** Generic function to tick on the horizontal axis.

**Details** Default of direction is "s1". Minor adjustments are not displayed on the Euclidean view, you have to check the results on the PDF file. The length of tickmarks can be set by the function [Setmarklen\(\)](#).

### Examples

```
Htickmark([1,"1",2,"n1",2,"3","se",3,"4","4"]);
```

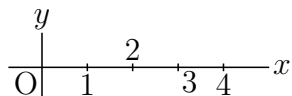

```
ticks=apply(-5..5,x,[x,text(x)]); // ticks is [ [-5,"5"],..., [5,"5"] ]
ticks=remove(ticks,[0,"0"]); // [0,"0"] is removed
ticks=flatten(ticks); // ticks becomes [-5,"5",...,5,"5"]
Htickmark(ticks);
```

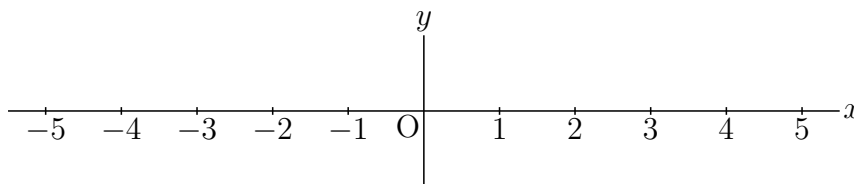

**Reference** [Vtickmark](#).

[⇒Command List](#)

## Vtickmark

**Usage** Vtickmark([y-coord,[direction(optional)],expression,...]);

**Description** Generic function to tick on the vertical axis.

**Details** Default of direction is "w1".

### Examples

```
Vtickmark([1,"1",2,"2"]);
```

**Reference** [Htickmark](#).

[⇒Command List](#)

## Rulerscale

**Usage** Rulerscale(starting point, horizontal marks, vertical marks);

**Description** Generic function to put ruler marks.

**Details** The marks are give as a list.

["r",a,b,c,d] to put marks from a to b with intervals c, scales d.

["f",n1,"str",n2,"str", ] to put marks as the same format as Htickmark.

### Examples1

```
Listplot("1", [[2,1], [9,1]]);
Rulerscale([2,1], ["r",2,9,1,10], []);
```



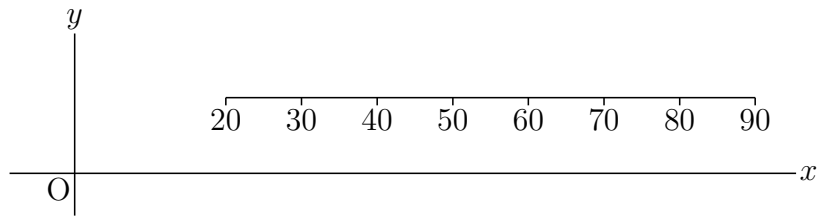

## Examples2

```
Framedata("1", [A,B], ["corner"]);
Rulerscale(A, ["r", 0, 5, 1], ["f", 1, "d1", 3, "d2"]);
```

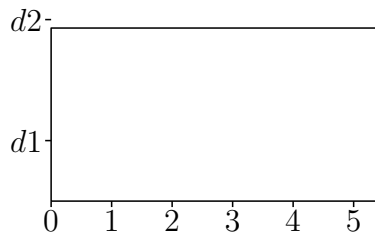

[⇒Command List](#)

## 1.3 Using plotting data

### Changestyle

- Usage**            Changestyle(list of PD, options)
- Description**    Change the option for drawing.
- Details**            Change the option for drawing several shapes altogether.

#### Examples

Draw segment AB and Circle AB with broken line on the Euclidean view and keep them from being drawn on  $\text{\TeX}$  final output.

```
Listplot([A,B]);
Circledata([A,B]);
Changestyle(["sgAB", "crAB"], ["da", "notex"]);
```

[⇒Command List](#)

### Drawfigures

- Usage**            Drawfigures(or Drwfigs)(name,List of PDs,List of Options)
- Description**    Manipulate a plural number of PDs together.
- Remark**            List of Options should corrensponds to that of PDs.
- Examples**        After manipulating PDs of a circle and a point on the circle by AddGraph, you can translate or rotate them together.

```

opcr=["dr"];
oppt=["Size=2","Color=red"];
Circledata("1",[[0,1],[0,0]],opcr);
Pointdata("1",[0,0],oppt);
ad1=["cr1","pt1"];
dt=2*pi/32;
opcr=["dr,0.3"];
nn=32;
forall(1..nn,
  t=dt*#;
  Rotatedata(2,ad1,-t,[[0,1],"nodisp"]);
  Translatedata(2,"rt2",[t,0],["nodisp"]);
  Drawfigures(text("#),["tr2_1","tr2_2"],[opcr,oppt]);
);

```

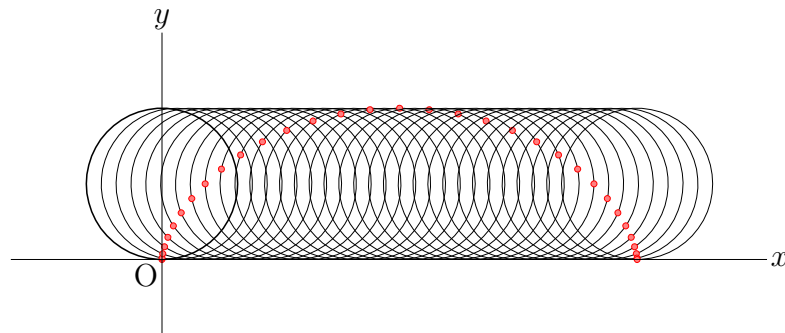

[⇒Command List](#)

## Invert

**Usage**      Invert(PD)

**Description**    Rearrange plotting data in the reverse order.

### Examples

See the examples in [Shade](#)

[⇒Command List](#)

## Joincrvs

**Usage**      Joincrvs(name, list of PDs, options)

**Description**    Create a plotting data of one curve by connecting a list of plotting data of adjacent curves.

**Details**      The list of curves is specified in the adjacent order.  
Options is line type.

### Examples

Draw the closed curve obtained from the line segment  $y = x$  ( $-\sqrt{2} \leq x \leq \sqrt{2}$ ) and the half circle, and paint the interior of the closed curve using the yellow color.  
Put the point A at the origin and the point B in the appropriate place.  
Plotdata("1","x","x=[-sqrt(2),sqrt(2)]");

```

B.xy=[sqrt(2),sqrt(2)];
Circledata("2", [A,B], ["Rng=[pi/4,pi/4*5]"]);
Joincrvs("1", ["gr1", "cr2"]);
Shade(["join1"], ["Color=yellow"]);

```

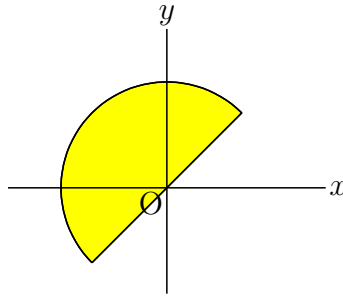

[⇒Command List](#)

## Partcrv

**Usage** Partcrv(name, A, B, PD, options)

**Description** Generic function to make a piece of curve from the PD between the points A and B.

**Details** The order of two points A, B must be same as the direction of the curve.  
Options are "dr, n", "da,m,n" or "do,m,n"

### Examples

In the following example We draw a parabola with dotted line and draw a piece of curve with real line.

```

Plotdata("1", "x^2", "x", ["do"]);
Partcrv("1", [0,0], [1,1], "gr1");

```

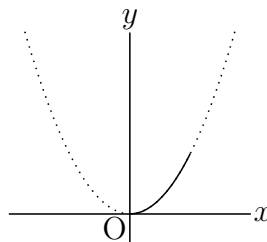

In the next example we draw a piece of circle with real line. The direction of a circle is counterclockwise direction.

```

Circledata([A,B], ["do"]);
Plotdata("1", "x^2", "x", ["do"]);
tmp=Intersectcrvs("crAB", "gr1");
P.xy=tmp_1;
Q.xy=tmp_2;
Partcrv("1", P, Q, "crAB");
Partcrv("2", Q, P, "crAB");

```

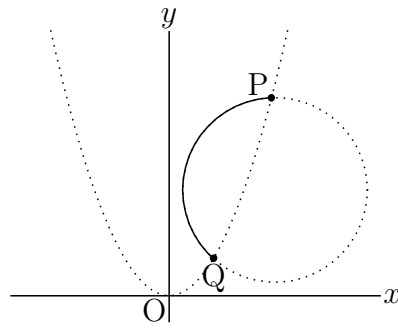

figure of part1

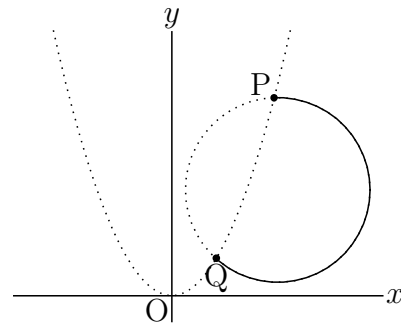

figure of part2

In the last example we draw the pice of parabola:  $y = x^2$  which is cut off by the circle.

```

Circledata("1", [[0,2], [0,0]], ["da"]);
Plotdata("1", "x^2", "x", ["do"]);
tmp=Intersectcrvs("cr1", "gr1");
Partcrv("2", tmp_2, tmp_1, "gr1", ["dr, 2"]);

```

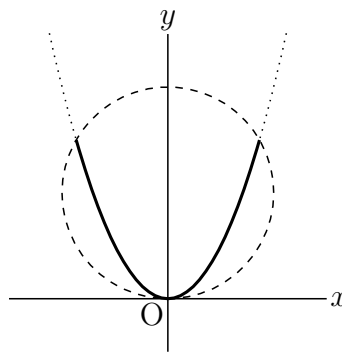

[⇒Command List](#)

## Enclosing

**Usage** Enclosing(name, a list of plotdata, options);

**Description** This function makes a closed curve form the list of plotdata.

**Details** Options are:

near point from start position : Set in case where the first curve and the last curve have multi intersects.

"dr", "da", "do", "`notex", "nodisp", "Color= " : as usual.

### Examples

```

Plotdata("1", "x^2", "x");
Lineplot("1", [[0,0], [1,0]]);
Lineplot("2", [[2,0], [2,1]]);
Enclosing("1", ["Invert(gr1)", "ln1", "ln2"], ["nodisp"]);
Shade(["en1"], ["Color=red"]);

```

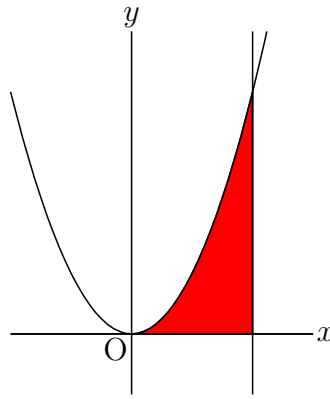

Remark The followings have the opposite direction.

```
Enclosing("1", ["ln1", "ln2", "Invert(gr1)"]);
Enclosing("1", ["gr1", "Invert(ln2)", "Invert(ln1)"]);
```

[⇒Command List](#)

## Hatchdata

**Usage** Hatchdata(name, a list of "i" or "o", a list of a list of PD, options)

**Description** Generic function to draw hatch lines in the close curve.

**Details** Options are:

- angle(degree,45), interval(ratio,1) of hatches,
- "Max=(default:20)" maximum of the number of hatches.
- "No=pointlist" not executed when any point is selected
- "File=y/m/n(default:n)" whether to make data file or not
- "Check=pointlist" data file updated if any point is changed

### Examples

```
Circledata([A,B], ["dr"]);
Hatchdata("1", ["i"], [{"crAB"}], ["dr,0.7"]);

Circledata([A,B], ["dr"]);
Paramplot("1", "[4*cos(t),2*sin(t)]", "t=[0,2*pi]");
Paramplot("2", "[2*cos(t),4*sin(t)]", "t=[0,2*pi]");
Hatchdata("1", ["ioi"], [{"crAB"}, {"gp1"}, {"gp2"}], ["dr,0.7"]);
Hatchdata("2", ["iio"], [{"crAB"}, {"gp1"}, {"gp2"}], ["dr,0.7"]);
```

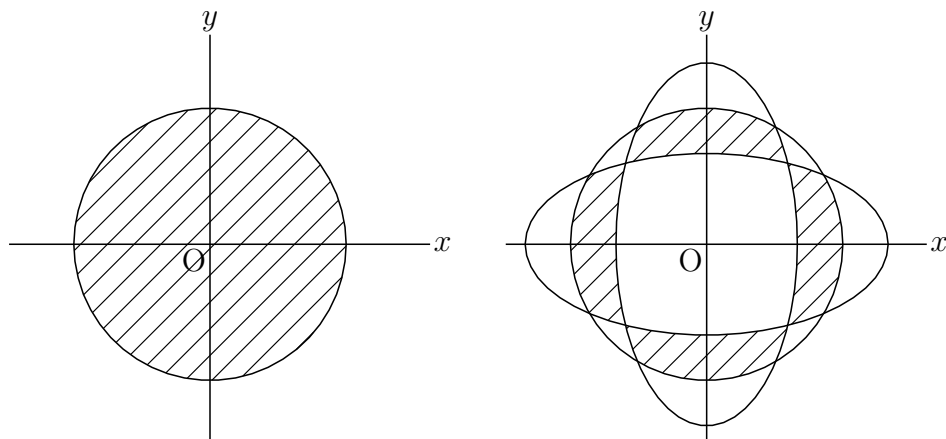

```

Plotdata("1","2*sin(x)","x=[-pi,3*pi]","Num=100");
Listplot([A,B]);
Listplot([A,C]);
Hatchdata("1",["ii"],[["sgAB","n"],["gr1","s"]],["dr,0.7"]);
Hatchdata("2",["ii"],[["sgAC","s"],["gr1","n"]],["dr,0.7"]);

```

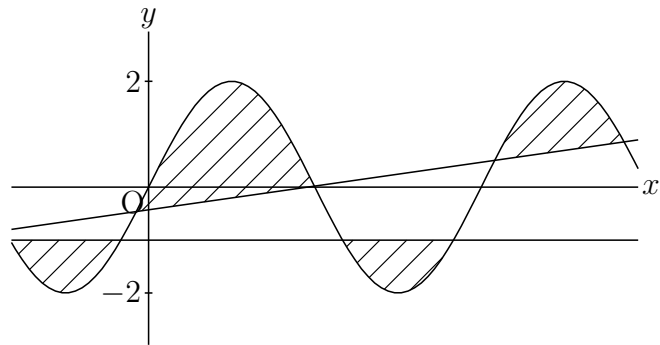

```

Plotdata("1","2*sin(x)","x=[-pi,3*pi]","Num=100");
Listplot([A,B]);
Listplot([A,C]);
Hatchdata("1",["iio"],[["sgAB","s"],["sgAC","n"],["gr1","n"]]);

```

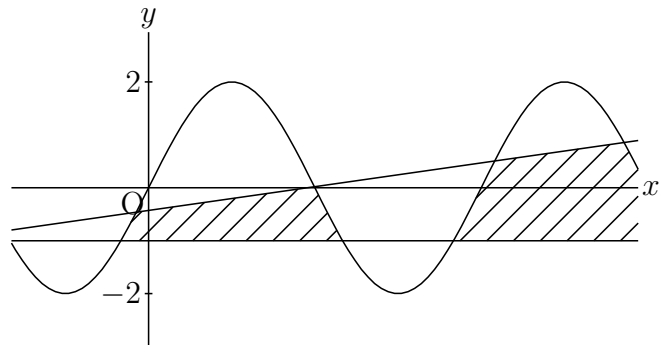

```

Deffun("f(x)",["regional(y)","y=x^3-2*x","y"]);
Plotdata("1","f(x)","x",["Num=100"]);
Putoncurve("A","gr1");
coef=Derivative("f(x)","x",A.x);
Defvar(["coef",coef]);
Deffun("g(x)",["regional(y)","y=coef*(x-A.x)+A.y","y"]);
Plotdata("2","g(x)","x",["Num=1"]);
if(!Ptselected(), // if any point is not selected
    Enclosing("1",["gr2","Invert(gr1)"],[A,"nodisp"]);
    Hatchdata("1",["i"],[["en1"]]);
);

```

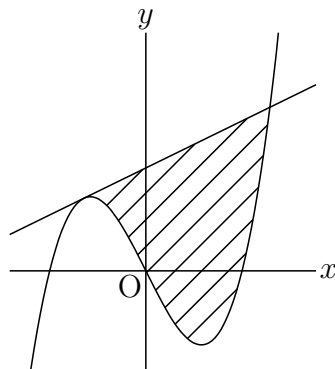

```

Circledata([A,B]);
Hatchdata("1",["i"],[["crAB"]]);
Hatchdata("2",["i"],[["crAB"]],[-40,2]); // angle = -40°, interval = ×2|
Hatchdata("3",["i"],[["crAB"],["dr,0.5"]]);
Hatchdata("4",["i"],[["crAB"],[-45,2,"dr,0.5"]]);

```

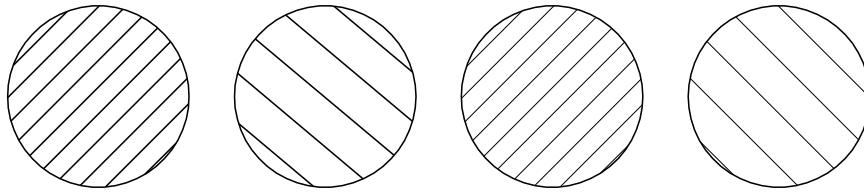

```

Lineplot("1",[A,B]); // name of this data is ln1
Lineplot("2",[A,C]);
Hatchdata("5",["iii"],[["crAB"],["ln1","n"],["ln2","n"]]);
Hatchdata("6",["ioo"],[["crAB"],["ln1","n"],["ln2","n"]]);

```

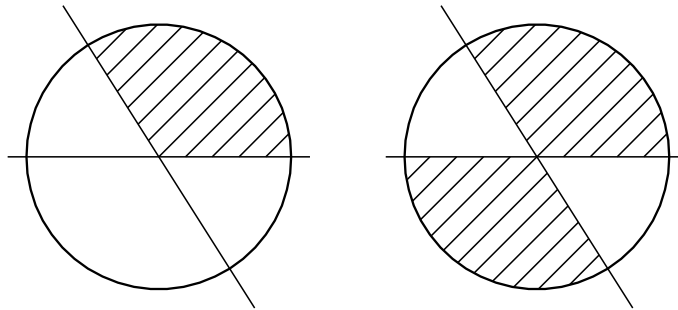

```

Circledata([A,B],["nodisp"]);
Hatchdata("7",["i"],[["crAB"]]);
Circledata([A,B],["da"]);
Hatchdata("8",["i"],[["crAB"]]);

```

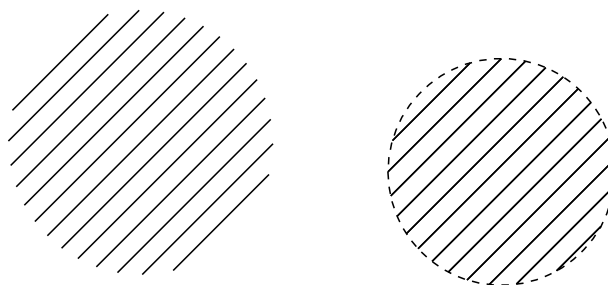

[⇒Command List](#)

## Dotfilldata

**Usage** Dotfilldata(name, list of the dotted sides "i" or "o", list of PD, option)

**Description** Fill a domain with dots.

**Details** R is called to generate the data. Arguments are the same as Hatchdata. Option is the density of dots from 0.1 to 0.8 (default is 0.3).

## Examples

A pie chart

After making closed curve via `Partcrv()` and `Enclosing()`, the surrounded region is filled with dots.

```
r=3;
p0=r*[cos(pi/2),sin(pi/2)];
p1=r*[cos(-pi/6),sin(-pi/6)];
p2=r*[cos(-3*pi/4),sin(-3*pi/4)];
Circledata("1",[[0,0],[r,0]]);
Listplot("1",[[0,0],p0]);
Listplot("2",[[0,0],p1]);
Listplot("3",[[0,0],p2]);
Partcrv("1",p1,p0,"cr1");
Enclosing("1",["sg2","part1","Invert(sg1)"],[[0,0]]);
Partcrv("2",p2,p1,"cr1");
Enclosing("2",["sg3","part2","Invert(sg2)"],[[0,0]]);
Dotfilldata("1",["i"],[["en1"]]);
Dotfilldata("2",["i"],[["en2"]], [0.1]);
```

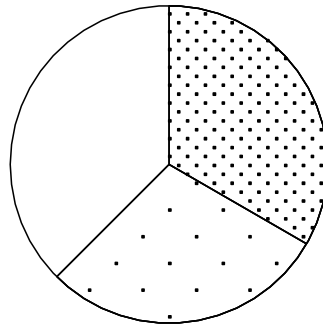

[⇒Command List](#)

## Shade

**Usage** `Shade(("name"),list of PD, options);`

**Description** This function fills a domain surrounded by a closed curve.

**Details** Options are as follows. `()` means the default.

- Starting point. The defaults are the intersect of the first curve and the last one.
- "Color="
- "Enc=n(y)" Whether `Enclosing` is used.
- "Trim=n(y)" Whether it is trimmed in the window.
- "First=y(n)"

Whether `Shade` is placed at the top in  $\text{T}_{\text{E}}\text{X}$ . The default is just before `Gdata`.

## Examples

```
Setax([7,"nw"]);
Plotdata("1","2*sin(x)","x",["Num=100"]);
Lineplot("1",[[0,1],[1,1]]);
Shade(["ln1","Invert(gr1)],[[2.5,1],"Color=0.2*[0,0,0,1]"]);
```



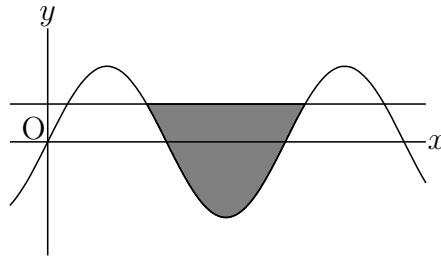

```
Plotdata("1","x^2-1","x=[-3,3]");
Plotdata("2","x^2/2","x=[-3,3]");
Shade("1",["gr2","Invert(gr1)"],[[-1.5,1],"Color=[1,0,0]","alpha->0.4"]);
```

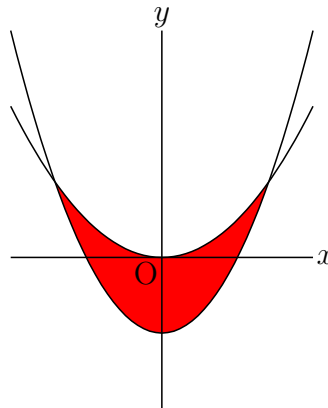

```
r1=2;
r2=1.5;
Circledata("1",[A,A+[r1,0]]);
Circledata("2",[A,A+[r2,0]]);
Listplot("1",[A+[r1,0],A+[r2,0]],["nodisp"]);
Shade(["cr1","sg1","Invert(cr2)","Invert(sg1)],["Enc=n","Color=green"]);
```

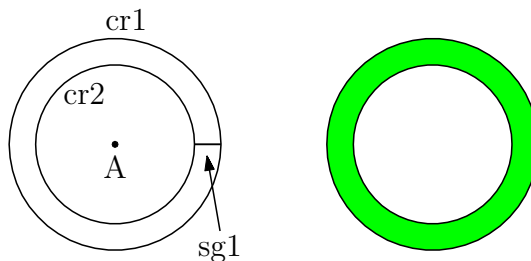

Reference [Joincrvs](#).

[⇒Command List](#)

## Reflectdata

**Usage** Reflectdata(name, PD, center or axis of symmetry, options);

**Description** Generic function to draw a reflective curve.

**Details** axis of symmetry is defined as a list of 2 points.

## Examples

```
Circledata([A,B]);  
Reflectdata("1","crAB",[C]);  
Reflectdata("2","crAB",[[-1,2]],["dr,2"]);  
Reflectdata("3","crAB",[D,E],["da"]);
```

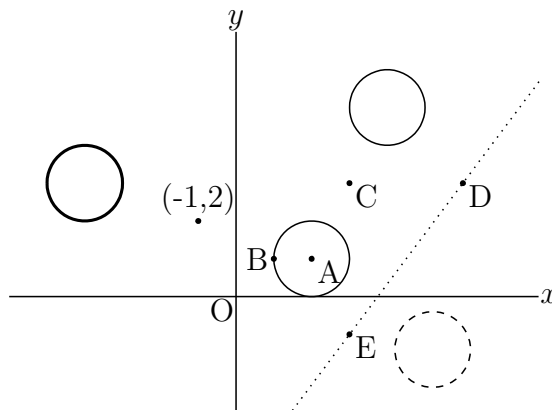

[⇒Command List](#)

## Rotatedata

**Usage** Rotatedata(name, (a list of )PD, angle(degree), options);

**Description** Generic function to rotate plotting data.

**Details** Options are center, and as usual. The default of center is [0,0].

## Examples

```
Circledata([A,B]);  
Rotatedata("1","crAB",pi/2,[C]);  
Rotatedata("2","crAB",pi/3,[[1,5],["dr,2"]]);  
Rotatedata("3","crAB",-pi/3,[D,"da"]);
```

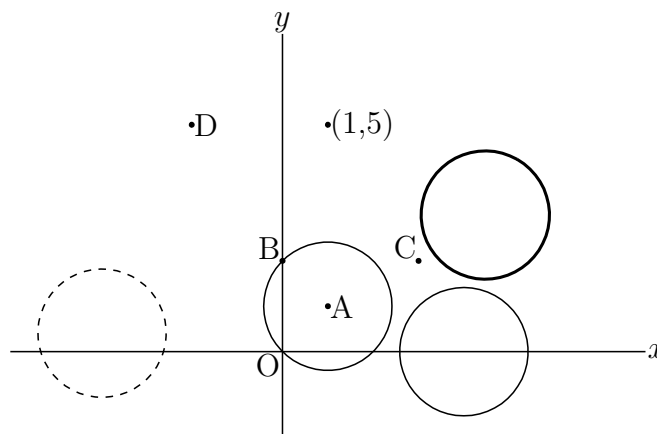

[⇒Command List](#)

## Scaledata

**Usage** Scaledata(name, list of PD, horizontal ratio, vertical ration, [options]);

**Description** Generic function to scale plotting data.

**Details** Options are Center, and as usual. The default of center is [0,0].

### Examples

```
Circledata([A,B]);  
Scaledata("1","crAB",3,2,[[0,0]]);  
Scaledata("2","crAB",3,2,[C,"dr,2"]);  
Scaledata("3","crAB",D.x,D.y,[[0,0],"da"]);
```

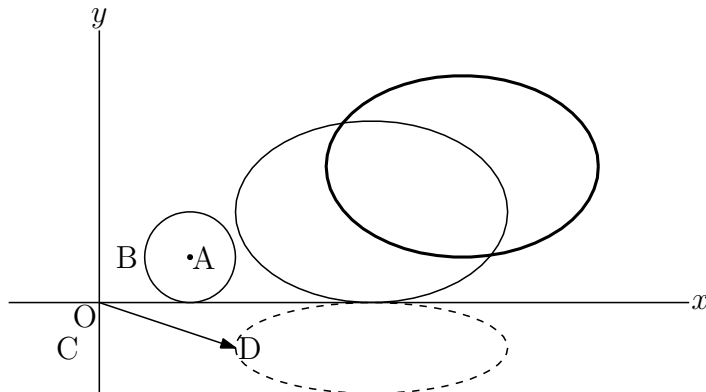

[⇒Command List](#)

## Translatedata

**Usage** Translatedata(name, list of PD, vector, options);

**Description** Generic function to translate plotting data.

**Details** Options are Center, and as usual. The default of center is [0,0].

### Examples

```
Circledata([A,B]);  
Translatedata("1","crAB",[2,3]);  
Translatedata("2","crAB",C,["dr,2"]);  
Translatedata("3","crAB",D,["da"]);
```

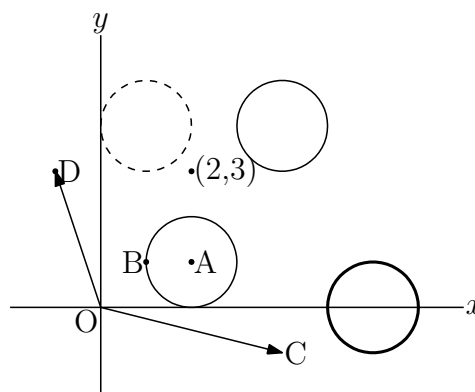

[⇒Command List](#)

## 1.4 Calculus and I/O

### Derivative

#### Usage

```
Derivative(function(string), variable(string), value);  
Derivative(PD(string), pointinfo, ([nth of intersects]));
```

**Description** Generic function to find the derivative of a function or a plotting data.

**Details** The pointinfo is one of "x=xvalue", "y=yvalue", [point, parameter].  
The option of nth is used to set the number when plotting data has multi intersects.

#### Examples

```
Defun("f(x)", ["regional(y)", "y=x^3-4*x", "y"]);  
coef=Derivative("f(x)", "x", A.x);  
A.y=f(A.x);  
B.y=coef*(B.x-A.x)+A.y;  
Plotdata("1", "f(x)", "x", ["Num=200"]);  
Lineplot([A,B]);  
Letter([A,"ne", "A"]);
```

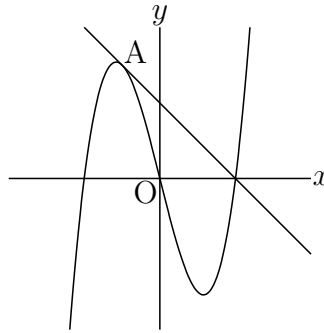

**Reference** [Tangentplot.](#)

[⇒Command List](#)

### Integrate

#### Usage

```
Integrate(function or name of PD, "varname=range", [options]);
```

**Description** Generic function to find the value of numerical integration.

**Details** Oshima's Bezier formula is used.

#### Examples

```
f(x) := x^3 - 2*x^2 + 2;  
val=Integrate("f(x)", "x=[0,3]");  
println(val); // 8.25 will be displayed.  
plotting data("1", "x^3-2*x^2+2", "x");  
println(Integrate("gr1", [0,3]));
```

[⇒Command List](#)

## Inversefun

**Usage** Inversefun(function(string), range, value);

**Description** Generic function to find the value of the inversefunction.

**Details** The value is found in the range.

### Examples

```
x=Inversefun("sin(x)","x=[0,pi/2]",0.5);  
The value of x is 0.5236.
```

[⇒Command List](#)

## Crossprod

**Usage** Crossprod(vec1, vec2);

**Description** Generic function to return the cross product of 2 vectors.

**Details** The vectors are a list with length 3 or 2.

### Examples

```
v=Crossprod([1,0,0],[1,1,1]); // The result is v=[0,-1,1].
```

[⇒Command List](#)

## Dotprod

**Usage** Dotprod(vec1, vec2);

**Description** Generic function to return the dot product of 2 vectors.

### Examples

```
v=Dotprod([1,2,3],[1,-1,1]); // The result is v=2.
```

[⇒Command List](#)

## Findarea

**Usage** Findarea(plotting data( or string of pd ));

**Description** Generic function to return the area enclosed with a close curve.

**Details** Oshima's Bézier formula is used.

### Examples

```
Paramplot("1","[3*cos(t),2*sin(t)]","t=[0,2*pi]");  
area=Findarea("gp1");  
println(Sprintf(area,6)); // The result is 18.849536.
```

[⇒Command List](#)

## Findlength

**Usage** Findlength(plotting data( or string of pd ));

**Description** Generic function to return the length of a curve.

**Details** Oshima's Bézier formula is used.

### Examples

```
Circledata("1", [[0,0],[2,0]]);  
len=Findlength("cr1");  
println(Sprintf(len,6)); // The result is 12.558097.
```

[⇒Command List](#)

## Intersectcurves

**Usage** Intersectcrvs(plotting data1(string), plotting data2(string));

**Description** Generic function to return a list of intersects of 2 plotting data.

### Examples

```
Plotdata("1", "sin(x)", "x", ["Num=100"]);  
Circledata([A, B]);  
tmp=Intersectcrvs("gr1","crAB");  
pP=tmp_1;  
pQ=tmp_2;
```

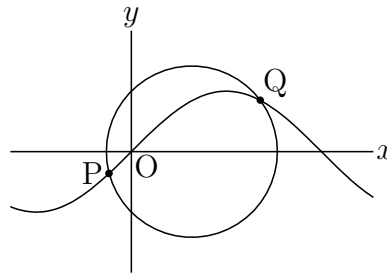

[⇒Command List](#)

## IntersectcurvesPp

**Usage** IntersectcrvsPp(plotting data1(string), plotting data2(string));

**Description** Generic function to return a list of intersects with parameters of 2 plotting data.

**Details** Parameters are positions of the intersect.

[⇒Command List](#)

## Nearestpt

**Usage** Nearestpt(plotting data1, plotting data2);

**Description** Generic function to return the nearest point with the parameter and the distance.

## Examples

```
Plotdata("1", "x^2+2", "x=[-2,2]");  
Plotdata("2", "-(x-2)^2+1", "x=[0,4]");  
plist=Nearestpt("gr1","gr2");  
Listplot("1",plist_1,plist_3);  
pB=plist_3;
```

**Remark** The returned list is  $[[0.4,2.16],31,[1.58,0.82],20.73,1.78]$ .

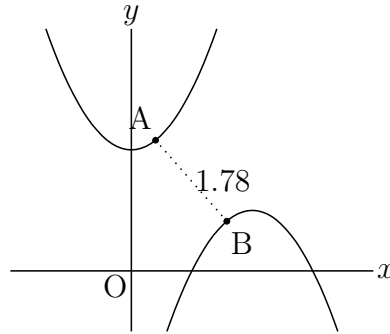

[⇒Command List](#)

## Nearestptcrv

**Usage** Nearestptcrv(point1, PD);

**Description** Generic function to return the nearest point on the PD from the point1.

## Examples

```
Plotdata("1", "x^2", "x");  
tmp=Nearestptcrv(A,"gr1"); //The coordnates will be returned.  
Putpoint("B",tmp);  
Listplot([A,B],["do"]);
```

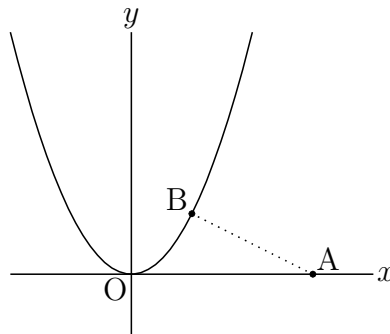

**Remark** The return value is  $[[0.4,2.16],31,[1.58,0.82],20.73,1.78]$ .

[⇒Command List](#)

## Numptcrv

**Usage** Numptcrv (PD)

**Description** Generic function to return the number of PD.

**Details** This is the same as `length(PD)`.

## Examples

```
Compare the order of PD, Implicit() and Paramplot(). ( on Euclidean view )
Slider("A-C-B", [0,-2], [6,-2]);
Implicitplot("1", "x^2+4*y^2=4", "x=[-2,2]", "y=[-2,2]", ["do"]);
Paramplot("1", "[2*cos(t)+5, sin(t)]", "t=[0,2*pi]", ["do", "Num=140"]);
println([Numptcrv(imp1), Numptcrv(gp1)]); //display number of PD on console
n=floor(C.x*2);
repeat(n,s,start->0,
  t=s*10+1;
  draw(imp1_t,color->hue(s/10));
  draw(gp1_t,color->hue(s/10));
);
```

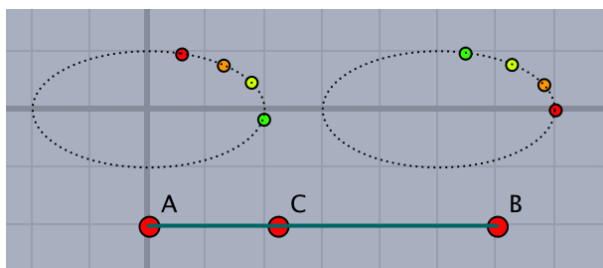

[⇒Command List](#)

## Paramoncurve

**Usage** Paramoncurve(point, PD)

**Description** Generic function to return the parameter value of the point on the curve.

**Details** The integer part is the number of the segment on which the point lies, the fractional part is the position on the segment.

## Examples

```
Listplot([A,B,C,A]);
Putonseg("D", [B,C]);
tmp=Paramoncurve(D, "sgABCA");
println(tmp); // for example display 2.35 on console.
```

[⇒Command List](#)

## Pointoncurve

**Usage** Pointoncrv(parameter value, plotting data);

**Description** Generic function to return the point which has the parameter value

## Examples

```
Circledata("1", [[0,0], [2,0]], ["Num=5", "Rng=[0,pi]"]);
tmp=Pointoncurve(4.5, "cr1");
Pointdata("1", tmp, ["Size=3"]);
Letter(tmp, "nw", "A");
```



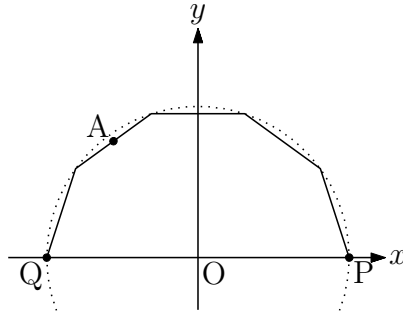

[⇒Command List](#)

## Ptcrv

**Usage** Ptcrv(n,PD);

**Description** Returns n-th point from PD.

**Details** Same as PD\_n of Cindyscript.

### Examples

```
Circledata([0,P],["do","Num=100","notex"]);
Scaledata("1","crOP",4/3,1);
F.xy=[-sqrt(7),0];
A=Ptcrv(9,sc1);
B=Ptcrv(16,sc1);
Listplot("1",[A,F,B],["da"]);
Partcrv("1",A,B,"sc1",["dr,3"]);
Shade(["part1","sg1"],0.1);
Arrowhead(B,"sc1",[1.5]);
Letter([A,"ne","A",B,"ne","B",F,"s2","F"]);
```

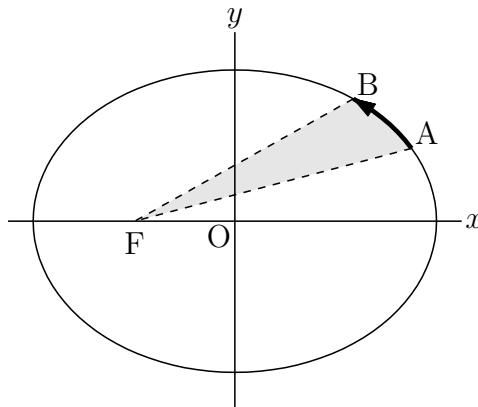

[⇒Command List](#)

## Ptstart, Ptend

**Usage** Ptstart(PD) , Ptend(PD)

**Description** Returns start point and end point of PD. respectively.

**Details** It returns coordinates of point.

**Examples** Gets the points at both ends of the graph with limited domain and draw the line segments.

```
Deffun("f(x)", ["regional(y)", "y=x^2", "y"]);  
Plotdata("1", "f(x)", "x", ["do"]);  
Plotdata("2", "f(x)", "x=[-1,2]");  
Lineplot("1", [Ptstart(gr2),Ptend(gr2)], ["do"]);  
Listplot("1", [Ptstart(gr2),Ptend(gr2)]);  
Letter([A, "w2", "A", B, "e2", "B"]);
```

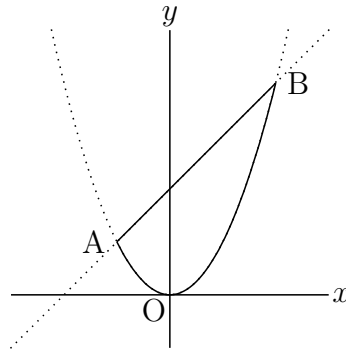

[⇒Command List](#)

## Readcsv

**Usage** Readcsv(path,filename,option)

**Description** read an external data file in csv format. The return value is a list of the data.

**Details** The first argument sets a path to the current working folder where the data file is (the default is fig). If you put the data file in fig folder, the pathname can be omitted. Otherwise a full pathname is required.

option: By the argument "Flat=y", you can flatten a list of the data (the default is "Flat=n").

**Examples** Examples can be found in the command Boxplot().

[⇒Command List](#)

## Readlines

**Usage** Readlines(path,filename,option)

**Description** read a text file line by line. The return value is a list of strings.

**Details** The first argument sets a path to the current working folder where the data file is (the default is fig). If you put the data file in fig folder, the pathname can be omitted. Otherwise a full pathname is required.

option: By the argument "Flat=y", you can flatten a list of the data (the default is "Flat=n").

[⇒Command List](#)

## ReadOutData

**Usage**            `ReadOutdata(filename);`

**Description**    Generic function to read external data of K<sub>E</sub>T<sub>C</sub>indy format.

**Details**            If the data is outside the working directory, add the path name as the first argument. For example,

```
ReadOutdata("/datafolder","file.txt");
```

K<sub>E</sub>T<sub>C</sub>indy format data is next style.

```
variable name//
start //           : start of list
[ , , ], .... //   : coordinates ( 2 or 3 dimension )
....
end//              : end of list
start//           : start of next list
....
end//
variable name//
start//
...
end////
```

**Reference**        [WriteOutData.](#)

[⇒Command List](#)

## WriteOutData

**Usage**            `WriteOutdata(filename, a list of varname and value);`

**Description**    Function to write out data in K<sub>E</sub>T<sub>C</sub>indy format.

**Details**            The file is available commonly from K<sub>E</sub>T<sub>C</sub>indy, R and C.

### Examples

Write out the plotting data of the parabola and the circle.

```
Plotdata("1", "x^2","x");
Circledata("1", [[0,0],[1,0]]);
WriteOutData("figdata.txt", ["gr1",gr1,"cr1",cr1]);
```

The written data is as follows.

```
gr1//
start// [[-2.68843,7.22765],[ -2.51807,6.34067], , [-2.00698,4.02798]]//
[[ -1.83662,3.37318],[ -1.66626,2.77642], , [-1.15518,1.33443]]//
and so on
[[5.82965,33.98479]]//
end//
```

```

cr1//
start// [[1,0],[0.99211,0.12533],[0.96858,0.24869], , [0.80902,0.58779]]//
and so on
[[0.87631,-0.48175],[0.92978,-0.36812], , [1,0]]//
end////

```

**Reference** See [ReadOutData](#).

[⇒Command List](#)

## Extractdata

**Usage** Extractdata(dataname,options);

**Description** Function to add properties to a data.

**Details** The default properties are ["dr"].

### Examples

```

ReadOutData("figdata.txt");
Extractdata("gr1",["da"]);

```

**Reference** See [WriteOutData](#) and [ReadOutData](#).

[⇒Command List](#)

## 1.5 Making Tables

### Tabledata

**Usage** Tabledata(a list of widths, a list of height,a list of removals,[options]);

**Description** Table function to draw rules of a table.

**Details** The lower left is the origin.

The options are

"Setwindow=y/n" if "n", command setwindow is not executed.

"Move=point" The lower left changes to the point.

"Geo=n/y" if "y", geometric points are created.

integer decides to put names par each interval.

The unit of length is 1/10 of the grid of Euclidean view. The default is 1mm.

Control points are put on the row and column. The names are r0,r1,... and c0,c1,....

The points are movable.

**Remark** See [Tabledatalight](#)

### Examples

```

xL=[20,20,20,20];
yL=[10,10,10,10,10];
Tabledata(xL,yL,["Geo=y"]);

```

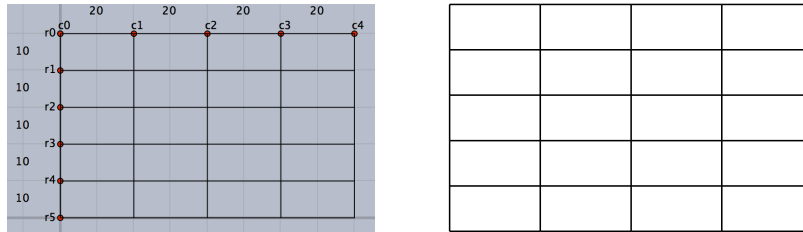

```
Rmv=["r1c0c1","c3r0r1","c3r3r5","r4c2c4"];
Tabledata(xL,yL,Rmv);
```

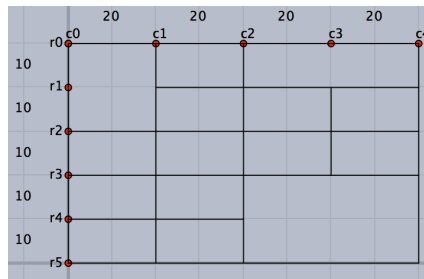

⇒Command List

### Changetablestyle

**Usage** ChangeTablestyle(a list of Rules, [changed style]);

**Description** Table function to change line styles of rules.

#### Examples

```
Tabledata([10,20,10,20],[10,10,10],[]);
ChangeTablestyle(["r1c0c4"],["da"]);
ChangeTablestyle(["r2c0c2","c1r0r3"],["nodisp"]);
```

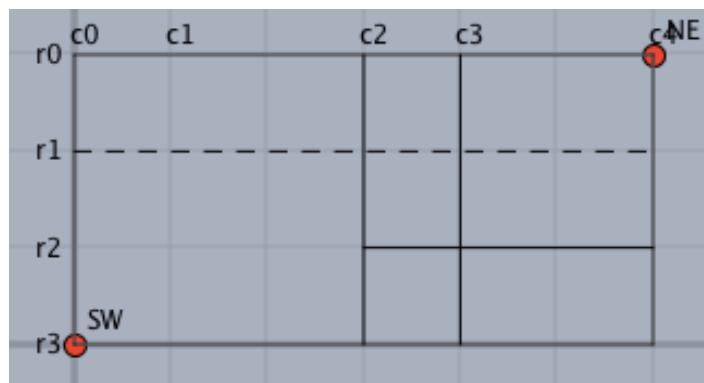

⇒Command List

### Findcell

**Usage** Findcell(grid name of upper left, grid name of lower right);

**Description** Table function to return the information of a cell.

**Details** The grid name is, for example, "c0r1".  
The result is a list of center, half of width, half of height.

### Examples

```
Tabledata([10,20,10,20],[10,10,10],[ ]);  
tmp=Findcell("c2r0","c3r1"); The return is [[3.5,2.5],0.5,0.5].  
tmp=Findcell("c0r1","c2r3"); The return is [[1.5,1],1.5,1] .
```

[⇒Command List](#)

## Putcell, Putcellexpr

**Usage** Putcell(grid name of upper left, grid name of lower right, position, a string);

**Description** Table function to put a string at the cell.

**Details** The position is one of **c**, **r**, **l**, **t**, **b** (center, right, left, top, bottom).  
Minute movements can be added.

### Examples

```
xL=apply(1..5,20);  
yL=apply(1..2,20);  
rL=["c2r2r3","c5r2r3"];  
Tabledata(xL,yL,rL);  
Putcell("c0r0","c1r1","c","A");  
Putcell("c1r0","c3r1","l2","B");  
Putcell("c0r1","c2r2","rt","C");  
Putcell("c3r1","c5r2","lb","D");
```

A	B			
		C		
			D	

[⇒Command List](#)

## Putcol

**Usage** Putcol (column number, position, a list of strings);

**Description** Table function to put strings to a column.

**Details** The position is as `Putcell`.  
It's unnecessary to enclose with double quotes in case of numbers.  
Null string is available.

**Reference** [Putrow](#).

## Putcolexpr

**Usage** Putcolexpr (column number, position, a list of mathematical expressions);

**Description** Table function to put strings to a column.

**Reference** [Putrowexpr](#).

⇒Command List

## Putrow

**Usage** Putrow (row number, position, a list of strings);

**Description** Table function to put strings to a row.

**Reference** [Putcol](#).

⇒Command List

## Putrowexpr

**Usage** Putrowexpr(row number, position, a list of strings);

**Description** Table function to put strings to a row.

**Examples** In Putcolexpr (), Putrowexpr (), formulas and general  $\text{\TeX}$ sentences can be entered.

```
xL=apply(1..5,20);
xL=apply(1..3,15);
Tabledata(xL,yL,["c1r1r2","r1c2c3","r2c2c3"]);
Putcol(3,"c",["A","B","C"]);
Putcolexpr(4,"1",["x^2","y=\sqrt{x^3}"]);
Putrow(1,"c",[1,"two"]);
Putrowexpr(3,"c",["","\frac{\pi}{2}","","","","\sum{x^2}"]);
```

	c0	c1	c2	c3	c4	c5
r0	1	two	A	$x^2$		
r1				B	$y = \sqrt{x^3}$	
r2		$\frac{\pi}{2}$	C			$\sum x^2$
r3						

**Remark** r0, c0, ... are numbers displayed on the screen.

**Examples** The graphs can be placed in the cells of the table. These are drawn at the position of the cell.

```
Tabledata("",3,3,120,90,["dr,2"]);
ChangeTablestyle(["r1c0c3"],["dr"]);
ChangeTablestyle(["r2c0c3"],["da"]);
Plotdata("1","(x-2)^2+1.5","x=[0.5,3.5]");
Plotdata("2","(x-6)^2+2","x=[4.5,7.5]");
Plotdata("3","(x-10)^2+2.5","x=[8.5,11.5]");
Listplot([A,B]);
Listplot([C,D]);
Listplot([E,F]);
Putrowexpr(1,"c",["D>0","D=0","D<0"]);
Putrow(2,"c",["2","1","0"]);
Letter(G,"c","The discriminant and the number of intersections");
```

The discriminant and the number of intersections

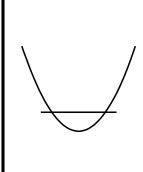
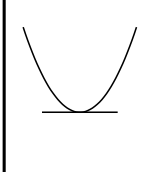
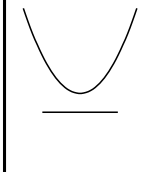
$D > 0$	$D = 0$	$D < 0$
2	1	0
		

**Examples**

```
Column=[6,6,10,6,10,6,40];
Row=[30,6,6,6];
Rmv=["c1r0r1","c2r0r1","c3r0r1","c4r0r1","c5r0r1","r1c6c7","r2c6c7","r3c6c7"];
Tabledata("",Column,Row,Rmv,["dr"]);
Tlistplot("23d",["c1r2","c2r3"]);
Tlistplot("23u",["c1r3","c2r2"]);
Putrowexpr(2,"c",["x",0,"\cdots","\tfrac{1}{4}","\cdots",4]);
Putrowexpr(3,"c",["y`","","-","0","+"]);
Putrowexpr(4,"c",["y",0,"\searrow","-\tfrac{1}{4}","\nearrow",2]);
Putcell(1,1,"l2t2",{"\small\begin{minipage}{44mm}$y=x-\sqrt{x}$\\$y`=\dfrac{2\sqrt{x}-1}{2\sqrt{x}}=0$\vspace{1mm}\\\hspace*{5mm}$x=\dfrac{1}{4}$\vspace{1mm}The following table is obtained.\\\end{minipage}" });
Plotdata("1","x-sqrt(x)","x=[0,3]","do","notex");
Listplot("2",[[0,0],[3,0]],["do","notex"]);
Listplot("3",[[0,-0.5],[0,3]],["do","notex"]);
Translatedata("1","gr1",[4.9,1],["dr"]);
Translatedata("2","sg2",[4.9,1],["dr"]);
Translatedata("3","sg3",[4.9,1],["dr"]);
Letter(Ptend(tr2),"e1","\small{$x$}");
Letter(Ptend(tr3),"n1","\small{$y$}");
Letter(Ptstart(tr2),"w1","\small 0");
Expr(Ptend(tr1),"nw-2","y=x-\sqrt{x}");
```



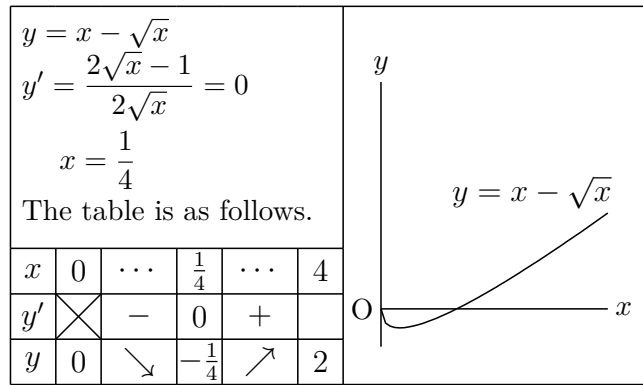

### Examples

```
Tabledata("",8,4,80,40,[]);
Putrowexpr(1,c,["x","\cdots","-1","\cdots","0","\cdots","1","\cdots"]);
Putrowexpr(2,c,["y`","+", "+", "+", "0", "-", "-", "-"]);
Putrowexpr(3,c,["y``,`", "+", "0", "-", "-", "-", "0", "+"]);
Putrowexpr(4,c,["y","\nelarrow","\frac{1}{\sqrt{e}}","\nerarrow",
"1","\serarrow","\frac{1}{\sqrt{e}}","\selarrow"]);
```

$x$	...	-1	...	0	...	1	...
$y'$	+	+	+	0	-	-	-
$y''$	+	0	-	-	-	0	+
$y$	$\curvearrowright$	$\frac{1}{\sqrt{e}}$	$\curvearrowleft$	1	$\curvearrowright$	$\frac{1}{\sqrt{e}}$	$\curvearrowleft$

### Remark

The arrows here are defined in `ketic.sty`.

`nelarrow`, `nerarrow`, `selarrow`, `serarrow`, `NElarrow`, `NErarrow`, `SElarrow`, `SErarrow`  
The first `ne` and `se` represent northeast and southeast (upper right and lower right), respectively. The next `r` and `l` represent the direction of rotation (`r`: right: counterclockwise, `l`: left: clockwise).

The straight arrows are `NEarrow`, `SEarrow`. Since these arrows do not exist in `CindyTEX`, they are not displayed on the drawing surface of `Cinderella`.

[⇒Command List](#)

## Tgrid

**Usage** `Tgrid(grid name);`

**Description** Table function to return the coordinates of the grid name.

[⇒Command List](#)

## Tlistplot

**Usage** `Tlistplot(grid name, grid name);`

**Description** Table function to connect two lattice points by line segments.

### Examples

```
Tlistplot(["c0r1", "c1r2"]);
```

[⇒Command List](#)

## 1.6 Data Processing

This section describes data processing by K<sub>ET</sub>Cindy. Cooperation with spreadsheet software enables efficient data processing.

### Tab2list

**Usage** Tab2list(string data, option);

**Description** Sheet function to convert contents of string data to list.

**Ditails** The options are as follows.

"Blank=a" : translate cells that is NULL to "a"

"Sep=b" : separators of the string are "b". The default separators are Tab code.

### Examples

In the Cindyscript editor, prepare a local variable, for example "data".

```
1 Ketinit();
2 Setfiles("DNA");
3
4 data="";
5
6 Windispg();
```

Copy the data on the spreadsheet to the clipboard.

	A	B	C	D	E
1		A	T	G	C
2	colon bacillus	24.7	23.6	26	25.7
3	wheat	27.4	27.1	22.7	22.8
4	salmon	29.7	29.1	20.8	20.4
5	human	30.9	29.4	19.9	19.8
6					

Paste it during double quotes.

```
4 data=" A T G C
5 colon bacillus 24.7 23.6 26 25.7
6 wheat 27.4 27.1 22.7 22.8
7 salmon 29.7 29.1 20.8 20.4
8 human 30.9 29.4 19.9 19.8
9 ";
```

By executing "Tab2list(data)" get a list of matrix form.

```
10 dlist=Tab2list(data);
11 println(dlist);

/kc.sh executable
[[,A,T,G,C],[colon bacillus,24.7,23.6,26,25.7],[wheat,
27.4,27.1,22.7,22.8],[salmon,29.7,29.1,20.8,20.4],[human,
30.9,29.4,19.9,19.8]]
```

If it contains a null character cell (NULL), it defaults to null character. Therefore, if you want to set NULL to 0 for questionnaire processing etc., use option **Blank**.

```
dlist=Tab2list(data, ["Blank=0"]);
```

When CSV format data is copied from the file, the option is set to **sep**.

```
dlist=Tab2list(data, ["Sep=","]);
```

[⇒Command List](#)

## Dispmat

**Usage** Dispmat(list);

**Description** Display the list to matrix form in the console.

**Examples** In the example of Tab2list, put the obtained data in a matrix format.

```
10 dlist=Tab2list(data);
11 Dispmat(dlist);
```

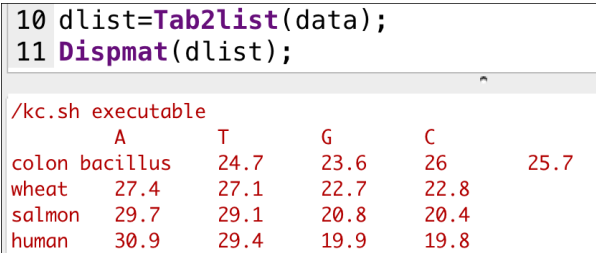

	A	T	G	C	
colon bacillus	24.7	23.6	26	25.7	
wheat	27.4	27.1	22.7	22.8	
salmon	29.7	29.1	20.8	20.4	
human	30.9	29.4	19.9	19.8	

You can copy this directly to spreadsheet.

[⇒Command List](#)

## Writecsv

**Usage** Writecsv(namelist, data, filename, option);

**Description** Make a CSV file consisting of the contents of data.

**Details** namelist is item name added to the first line of the CSV file. If the namelist omitted, the item names "c1, c2, ..." are appended.

The filename is the name of CSV file.

option : "Col=nn" : Specify the number of columns in the CSV file as a natural number nn.

When specifying the number of columns is omitted, if data is a matrix, use that number of columns, and if data is a vector, use the number of items in namelist.

### Examples

```
Let data=[13,25,17,22,14,26] , name2=["aa","ab"] , name3=["ba","bb","bc"]
```

```
Writecsv(name2,data,"aaa");
```

makes the file "aaa.csv" consists of

```
aa,ab
```

```
13,25
```

```
17,22
```

14,26

```
Writecsv(name3,data,"aaa");  
makes the file "aaa.csv" consists of  
ba,bb,bc  
13,25,17  
22,14,26
```

```
Writecsv(,data,"aaa",["Col=3"]);  
makes the file "aaa.csv" consists of  
c1,c2,c3  
13,25,17  
22,14,26
```

[⇒Command List](#)

## 1.7 Others

### Assign

**Usage** Assign(string0, string1, number)

**Description** Generic function to replace the string1 in the string0 with the number. Number is real number or string of real number.

#### Examples

```
Assign("x^2+a*x","a","1.3"); // a*x → 1.3*x
Assign("x^2+a*x","a",1.3); //same as above
```

```
repeat(50,t,
  cb=t/5-5;
  Plotdata(text(t),Assign("b*x-b^2","b",cb),"x");
);
```

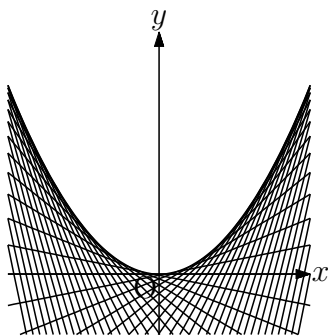

Perform multiple replacements by list.

```
Assign("a*x^2+b*x",["a",1,"b",2]); // a → 1 and b → 2
```

[⇒Command List](#)

### BBdata

**Usage** BBdata(file name, options);

**Description** Generic function to return the size of an image file.

**Details** In the  $\text{T}_{\text{E}}\text{X}$ document, find the BB size when pasting the image with the inputgraphics command. Create BB data from an image file using extractbb of  $\text{T}_{\text{E}}\text{X}$ processing system and write it as a text file to the working directory. Read this and write the includegraphics command to the console.

Options : specifies width and height. "w=" : width, "h=" : height

The value of bb is not an integer value, and it is indicated by rounding off the high definition value to two decimal places.

The image files are PDF, PNG, JPG, and so on.

#### Examples

```
10 BBdata("ellipsecindy.pdf");
11 BBdata("circle.png",["w=40mm"]);
12
\includegraphics[bb=0.00 0.00 272.01 240.01]{ellipsecindy.pdf}
\includegraphics[bb=0.00 0.00 306.02 219.01,width=40mm]{circle.png}
```

[⇒Command List](#)

## Asin

**Usage** Asin(real) , Acos(real)

**Description** Return arcsine and arccosine.

[⇒Command List](#)

## Sqr

**Usage** Sqr(real)

**Description** Return square root.

[⇒Command List](#)

## Colorcode

**Usage** Colorcode(colortype1,colortype2,colorcode)

**Description** Generic function to change colorcode from colortype1 to colortype2.

**Details** Return value is changed color code.

Color type is one of "rgb", "cmyk", "hsv".

### Example

RGB to CMYK

```
col=Colorcode("rgb", "cmyk", [1,0,0]);
```

CMYK to RGB

```
col=Colorcode("cmyk", "rgb", [0,1,1,0]);
```

RGB to HSV

```
col=Colorcode("rgb", "hsv", [1,0,0]);
```

[⇒Command List](#)

## Dqq

**Usage** Dqq(string);

**Description** This function returns a string surrounded by double quotes.

### Exaample

```
parse("a"); // The value of variable a is returned.  
parse(Dqq("a")); // String "a" is returned.
```

[⇒Command List](#)

## Factorial

**Usage** Factorial(n);

**Description** This function returns the factorial of `n`.

[ Details]`n` should be a positive integer.

**Example** `x=Factorial(5); // x is 120.`

[⇒Command List](#)

## Figpdf

**Usage** `Figpdf(option)`

**Description** Generic function to make a pdf with the same size of figure.

**Details** Option is a list of margin and the amount of translation.

- (1) Set the output file name with the command `Setparent("filename")`.
- (2) Push the "Parent" button.

"figure.tex" and "filename.tex" is created in fig folder. ( use "figure.cdy") filename.tex creates filename.pdf using figure.tex.

### Examples

```
Figpdf();           : default
Figpdf([5,5,10,10]); : left and right margins are 5mm
                  : top and bottom margins are 10mm.
Figpdf([[5,10]]);  : translation to right 5mm and to down 10mm.
Figpdf([5,8,10,10,[5,-5]]); : margin and translation
```

We have to take the right margin at least 3mm to draw the axis name.

[⇒Command List](#)

## Cindyname

**Usage** `Cindyname();`

**Description** Generic function to return the name of a current file without ".cdy".

### Examples

```
name=Cindyname(); // If current file is "sample.cdy", name="sample".
```

[⇒Command List](#)

## Indexall

**Usage** `Indexall(string1,string2);`

**Description** Generic function to return all positions of string2 in string1.

### Examples

```
str="abcadeaf"
pos=Indexall(str,"a");// Result is [1,4,7].
```

**Remarks** This command is an extension of "indexof" which is a command of CindyScript.

## Help

**Usage**      `Help(string)`

**Description**    Generic function to display usages of the function.

### Examples

`Help("L");` then we have the following result in console.

```
Letter([C,"c","Graph of $f(x)$"]);
Letter([C,"c","xy"],["size->30"]);
Letterrot(C,B-A,"AB");
Letterrot(C,B-A,"t0n5","AB");
Letterrot(C,B-A,0,5,"AB");
.....
```

## Norm

**Usage**      `Norm(vector);`

**Description**    This function returns the norm of the vector.

**Details**      The vector is 2D or 3D.

If two vectors  $v_1$ ,  $v_2$  are given, the value of `Norm(v2-v1)` is returned.

**Examples**      `Norm([1,1,2]);` //  $\sqrt{6}$  is returned.

## Op

**Usage**      `Op(number, list or string);`

**Description**    Generic function to return the n-th element of a list or a string.

### Examples

```
str="abcde"
list=[3,1,2,5];
s=Op(2,str);    // Result is "b".
x=Op(3,list);    // Result is 2.
```

## Ptselected

**Usage**      `Ptselected(name of points)`

**Description**    Generic function to returns "true" if a point is selected.



**Details** Commands such as `Hachdata` take time to execute, so interactive operations slow down the reaction. Therefore, while interactively operating, you can use this command to stop drawing.

## Examples

Draw the point A near the origin.

```

Deffun("f(x)", ["regional(y)", "y=x^3-2*x", "y"]);
Plotdata("1", "f(x)", "x", ["Num=100"]);
Putoncurve("A", "gr1");
coef=Derivative("f(x)", "x", A.x);
Defvar(["coef", coef]);
Deffun("g(x)", ["regional(y)", "y=coef*(x-A.x)+A.y", "y"]);
Plotdata("2", "g(x)", "x", ["Num=1"]);
if(!Ptselected(A),
  Enclosing("1", ["gr2", "Invert(gr1)"], [A, "nodisp"]);
  Hatchdata("1", ["i"], [{"en1"}]);
);

```

Dragging point A (select)

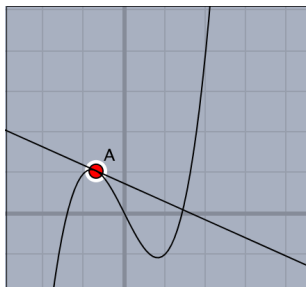

Unselected

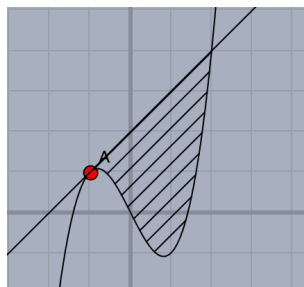

[⇒Command List](#)

## Reparse

**Usage** `Reparse(string or list of string)`

**Description** function to return the real part after `parse`

**Remark** `parse` of CindyJS has a bug to return an imaginary number in some cases.

## Examples

```

str="(0-1)^2";
format(parse(str),0); // returns 1+i*0 in CindyJS
format(Reparse(str),0); // returns 1

```

[⇒Command List](#)

## Slider

**Usage** `Slider("endpoint1-pt-endpoint2",endpoint1,endpoint2);`

`Slider("pt",endpoint1,endpoint2);`

**Description** Generic function to make a slider on a Euclidean view.

### Examples

```
Slider("A-C-B", [-5, -2], [5, -2]); // C is movable.  
Slider("D-F-E", [-6, -2], [-6, 2]); // F is movable.  
Plotdata("1", Assign("y=a*sin(x-b)", ["a", F.y, "b", C.x]), "x");
```

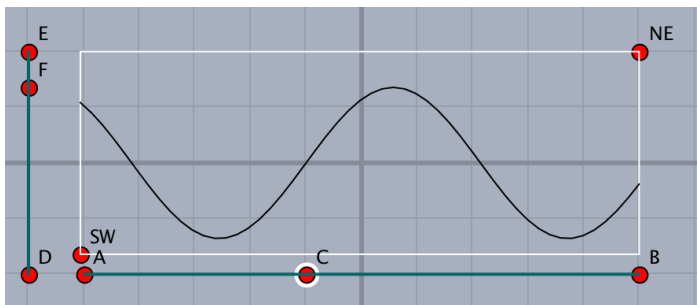

[⇒Command List](#)

## Sprintf

**Usage** Sprintf(value,number);

**Description** Converts a real number to a string.

**Details** Convert a real value to a string to the specified number of digits after the decimal point.

### Examples

```
Sprintf(pi,2); // returns "3.14".  
Sprintf(pi,7); // returns "3.1415927".
```

Remark : pi is a reserved variable in Cindyscript, representing the number  $\pi$ .

**Reference** See [Textformat](#).

[⇒Command List](#)

## Strsplit

**Usage** Strsplit(string,char);

**Description** Generic function to return the list of strings separated by char.

### Examples

```
str="abcadeaf"  
strL=Strsplit(str,"a"); // Result is ["", "bc", "de", "f"].
```

[⇒Command List](#)

## Texcom

**Usage** Texcom(command);

**Description** Generic function to add the command in the T<sub>E</sub>Xfile.

**Details** Command is a T<sub>E</sub>Xcommand in string.

### Examples

```
Texcommand("{");  
Texcommand("}");
```

[⇒Command List](#)

## Textformat

**Usage** Textformat(value,number);

**Description** Converts a real number to a string.

**Details** Convert a real value to a string up to the specified number of digits after the decimal point. "value" is can be list.

Cindyscript has a function `format(value, number)`, like as Textformat.

### Examples

```
Textformat(1/6,4); // return value is string "0.1667"  
format(1/6,4); // return value is string "0.1667"  
  
dt=[1/6,0.5];  
Textformat(dt,4); // return valu is string "[ 0.1667 , 0.5 ]"  
format(dt,4); // return value is list ["0.1667" , "0.5" ]  
Sprintf(dt,4); // return value is list ["0.1667","0.5000"]
```

**Reference** See [Sprintf](#).

[⇒Command List](#)

## Toupper

**Usage** Toupper(string);

**Description** This function returns the upper case letters of the string.

**Examples** Toupper("aBc123"); // "ABC123" is returned.

[⇒Command List](#)

## Windisp

**Usage** Windisp();

**Description** Generic function to display all graphs on Euclidean view.

**Remark** This command must be put on the final line.

[⇒Command List](#)

## Windisp

<b>Usage</b>	Windispg();
<b>Description</b>	Generic function to display all graphs on Euclidean view.
<b>Remark</b>	This command must be put on the final line.

[⇒Command List](#)

### **Fracform**

<b>Usage</b>	Fracform(number,list of denominators/max number[, allowable error(5)])
<b>Description</b>	returns Tex-like form of the fraction
<b>Examples</b>	Fracform(0.33,1..100); => [fr(33,100),'err=0',1,3]
<b>Examples</b>	Fracform(pi,200)); => [fr(355,113),err=0.0000002668,355,113]

[⇒Command List](#)

### **Tonormalform**

<b>Usage</b>	Tonormalform(Tex-like form without *)
<b>Description</b>	returns the string with *
<b>Examples</b>	Tonormalform("3x^2"); => 3*x^2

[⇒Command List](#)

### **Totexform**

<b>Usage</b>	Totexform(Tex-like form)
<b>Description</b>	returns TeX form
<b>Examples</b>	Totexform("fr(1,3)"); => frac{1}{3}

[⇒Command List](#)

### **Tocindyform**

<b>Usage</b>	Tocindyform(Tex-like form)
<b>Description</b>	returns Cindy form
<b>Examples</b>	Tocindyform("fr(1,3)"); => (1)/(3)

[⇒Command List](#)

## 2 Calling Other Softwares

### 2.1 R

#### Rfun

- Usage** Rfun(name, ommand,list of arguments,options)
- Description** This function executes a R command and returns the.
- Examples** Rfun("1", "rnorm", [10]); // The result will be assigned to "R1".
- Remark** Option "Cat=n" supresses display of the result in the console.

[⇒Command List](#)

#### CalcbyR

- Usage** CalcbyR(var,command,options)
- Description** executes R commands and returns the execution result to Cinderella.
- Details** exchange data with R through a batch file (kc.bat) or a shell file (kc.shell).
- Examples**

Generate 10 random samples from the standard normal distribution by R and return the result (data) to Cinderella.

```
cmdL=[
  "dt=rnorm", [10,50,5] ,
  "m=mean(dt)", [],
  "u=var(dt)", [],
  "dt::m::u", []
]
CalcbyR("ans",cmdL);
println("Data : "+ans_1);
println("Mean : "+format(ans_2,4));
println("UD : "+format(ans_3,4));
```

generate 200 random samples from the Poisson distribution with mean 5 and calculate the sample mean and the unbiased variance of the data.

```
cmdL=[
  "tmp1=rpois", [200,5] ,
  "tmp2=mean", ["tmp1"],
  "tmp3=var", ["tmp1"],
  "tmp2::tmp3::tmp1", []
];
CalcbyR("rd",cmdL);
dt=rd_(3..length(rd));
nn=length(dt);
mx=rd_1;
vx=rd_2*(nn-1)/nn;
sx=sqrt(vx);
```

```
println(dt);
println(["m="+format(mx,4) ,"v="+format(vx,4)]);
Setscaling(1/5);
```

create a histogram for the data, Breaks=seq(0,14,1) specifies the bin size.

```
Histplot("1",dt,["Breaks=seq(0,14,1)", "dr,0.5"]);
```

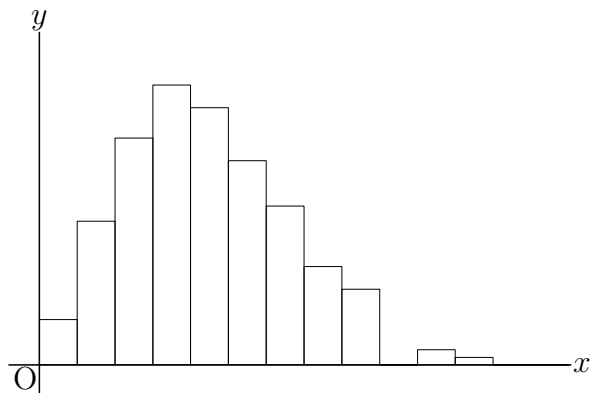

generate 2000 random samples from the Poisson distribution and calculate 200 sample means in 10 samples.

```
cmdL=[
  "tmp1=rpois", [2000,5],
  "tmp2=c()", [],
  "for(k in 1:200){", [],
  "  tmp=tmp1[(10*(k-1)+1):(10*k)]", [],
  "  tmp2=c(tmp2,mean(tmp))", [],
  "}", [],
  "=tmp2", []
];
CalcbyR("rd2",cmdL);
Setscaling(1/10);
Histplot("2",rd2);
```

[⇒Command List](#)

## Boxplot

**Usage**      Boxplot(name, data, vertical position, height of box,options);

**Description**    draw boxplots

### Examples

draw a boxplot of 100 uniform random numbers less than 5.

```
dt1=apply(1..100,5*random());
Boxplot("1",dt1,1,1/2);
```

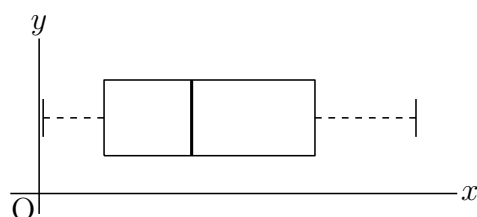

read an external data file in csv format and draw a boxplot of the data.

```
Boxplot("2","datafile.csv",3,1/2);
```

You can read a csv file with more than one column using `Readcsv`. The csv file should be stored in current working folder (default is fig folder). Using `Framedata` and `Rulerscale` together, you can mark with a scale. Before you use `Framedata`, you need to take two diagonal points of the drawing area on the Euclidean view.

```
data=Readcsv("datafile.csv");
dt1=apply(data,#_1);
dt2=apply(data,#_2);
Boxplot("1",dt1/20,1,1/2);
Boxplot("2",dt2/20,3,1/2);
Framedata("1",[A,B],["corner"]);
Rulerscale(A,["r",0,6,1],["f",1,"\mbox{dt1}",3,"\mbox{dt2}"]);
```

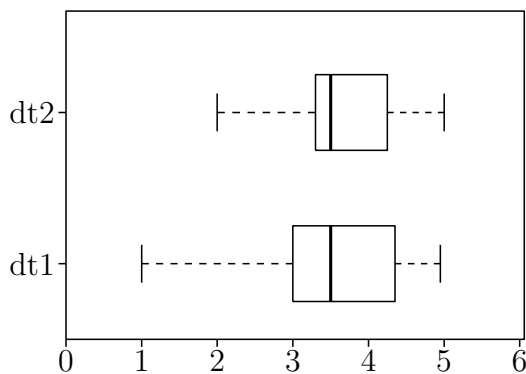

[⇒Command List](#)

## Histplot

**Usage**      `Histplot(name,data,options)`

**Description**    create histograms.

**Details**        data is given in a list or read an external data file in csv format.

Return value is list of breaks and frequency.

You can specify the breaks as a vector of points to get exactly what is wanted, for example

```
"Breaks=[0,10,20,30,40,50,60]" .
```

The Sturges algorithm is the default.

Other options:

```
"Rel=yes/no" : draw a histogram of proportions or frequencies (default is no)
```

## Examples

Read the data file in csv format (datafile.csv) and create a histogram of the data in a frame with a scale.

```
Addax(0);
Setscaling(5);
Setunitlen("0.6mm");
```

```

data=Readcsv("datafile.csv");
Histplot("1",data,[""]);
Framedata("1",[A,B],["corner"]);
Rulerscale(A,["r",0,100,10],["r",0,15,5]);

```

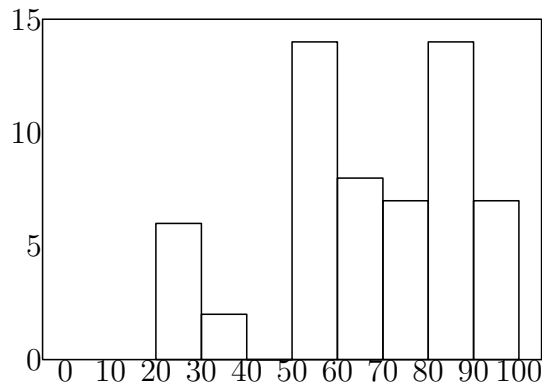

[⇒Command List](#)

## PlotdataR

**Usage** PlotdataR(name,formula,var)

**Description** Draw graph of R's statistical probability function.

**Details** Draw graphs of functions not built-in Cindyscript.

### Examples

#### Example1

draw graphs of the probability density function (p.d.f.) and the cumulative distribution function of  $N(5, 2^2)$ .

```

PlotdataR("1", "dnorm(x,5,2)", "x=[0,10]");
PlotdataR("2", "pnorm(x,5,2)", "x=[0,10]");

```

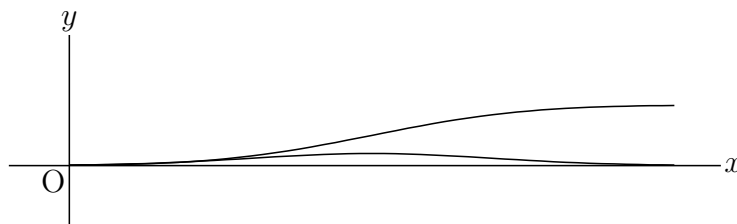

#### Example2

1. draw a graph of the p.d.f. of standard normal distribution.
2. shade the region under the graph and above x-axis to the left of A. x.
3. find the area of the shaded region.

```

PlotdataR("1","dnorm(x)","x=[-5,5]","Num=100");
Putpoint("A",[0,0],[A.x,0]);
Lineplot("1",[A,A+[0,1]],["nodisp"]);
Putintersect("B","grR1","ln1");
Listplot("1",[A,B]);
Listplot("2",[[-5,0],[5,0]],["nodisp"]);

```



```

Enclosing("1",["Invert(grR1)","sg2","sg1"],[B,"notex"]);
Shade(["en1"],["Color=[0.2,0,0,0]"]);
tmp=0.5+Integrate("grR1",[0,A.x]);
Expr([A,"s",text(A.x),C,"e","P="+text(tmp)]);

```

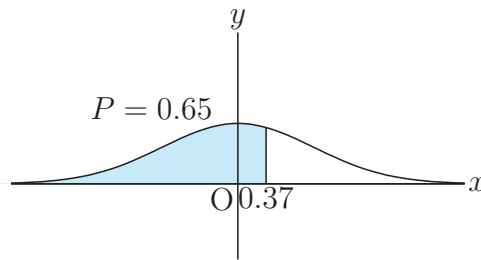

[⇒Command List](#)

## PlotdiscR

**Usage** PlotdiscR(name,fromaula,var)

**Description** draw graphs of discrete distributions by calling R's built-in functions.

**Details** The "d" functions in R to draw graphs of discrete distributions: dbinom (binomial distribution), dpois (poisson distribution), dgeom (geometric distribution), etc.

### Examples

The normal distribution with the same mean and standard deviation as the binomial distribution

```

Setscaling(20);
PlotdiscR("1","dbinom(k,10,0.4)","k=[0,10]");
PlotdataR("1","dnorm(x,10*0.4,sqrt(10*0.4*0.6))","x=[0,10]","do");

```



Example2

```

PlotdiscR("2","dpois(k,4)","k=[0,10]");
PlotdiscR("3","dgeom(k,0.3)","k=[0,10]");

```

[⇒Command List](#)

## Scatterplot

**Usage** Scatterplot(name,filename/datalist,options1,options2)

**Description** This command draw scatter plot reading a csv file.

**Details** Datafile is next style csv format.

2.3, 4.5 (LF)  
3.2, 7 (LF)  
2.0, 6.8 (LF)

If 2nd argument is datalist, next format.

```
data=[[2.3,4.5],[3.2,7],[2.0,6.8],    ];
```

Options1 are switch of draw the regression line or no , style of point.  
"Reg=yes(no:default)" to decide whether to draw the regression line.  
Options2 are position of drawing the regression line and style of line.  
Position is coordinate or name of point.

### Examples

```
Scatterplot("1","data.csv",["Size=4","Color=blue"],[A,"Color=green"]);  
Listplot("1",[[0,7],[0,0],[7,0]]);  
Rulerscale([0,0],["r",0,7,1],["r",1,7,1]);
```

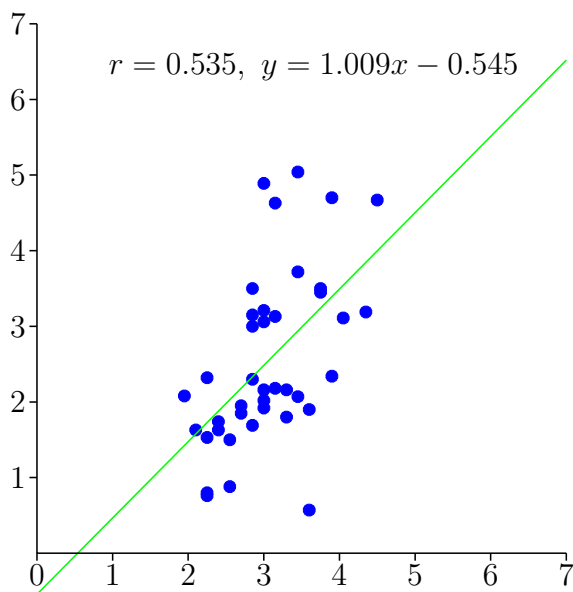

[⇒Command List](#)

## 2.2 Maxima

### CalbyM

**Usage** CalbyM(name, command,options)

**Description** Maxima's script execution

**Details** The second argument is a command to be executed by Maxima.

Create a list (eg. cmdL) consisting of a repetition of commands and argument lists, and execute at once.

There is no return value. For the result (of undefined value), the value of the variable of the command list last described (argument is the empty list) is assigned to the variable specified by "name". When you want to return more than one result, if you describe it by separating it with ":", it will be substituted into the list.

## Examples

Example1: derivative

```
cmdL=[
  "f:sin(x)", [],
  "df:diff", ["sin(x)", "x"],
  "f::df", []
];
CalcbyM("fdf", cmdL);
println(fdf);
```

Example2: solution of quadratic equation

```
cmdL=[
  "ans:solve", ["x^2-x-4", "x"],
  "ans", []
];
CalcbyM("ans", cmdL);
println("ans="+ans);
```

Example3:

```
fx="(exp(x)+exp(-x))/2";
cmdL=[
  "df:diff", [fx, "x"],
  "c:ev", ["df", "x=a"],
  "b:ev", [fx, "x=a"],
  "eq:c*(x-a)+b", [],
  "eq", []
];
CalcbyM("tn1", cmdL);
tn1=Assign(tn1, ["%e^a", "exp(a)", "%e^-a", "exp(-a)"]);
Plotdata("1", fx, "x");
PutonCurve("A", "gr1");
tmp=Assign(tn1, ["a", A.x]);
plotting data("2", tmp, "x", ["Num=2"]);
Letter([A, "se", "A"]);
```

Example4: Parametric

```
fn="3*cos(t)^2*[cos(t), sin(t)";
cmdL=[
  "f:", [fn],
  "df:diff", ["f", "t"],
  "df:trigsimp", ["df"],
```

```

"tn:f+s*df", [],
"tn", []
];
CalcbyM("tn2", cmdL);
Paramplot("1", fn, "t=[0,2*pi]", ["Num=100"]);
gn=Assign(tn2, ["t", A.x]);
Paramplot("2", gn, "s=[-3,3]");

```

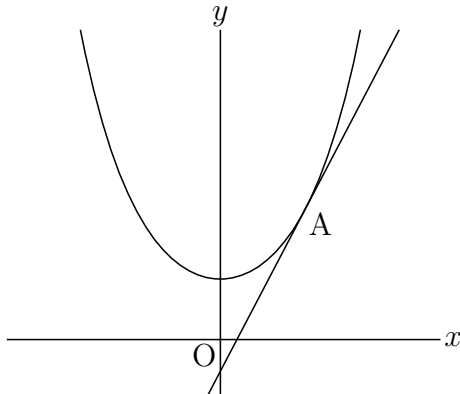

Example3

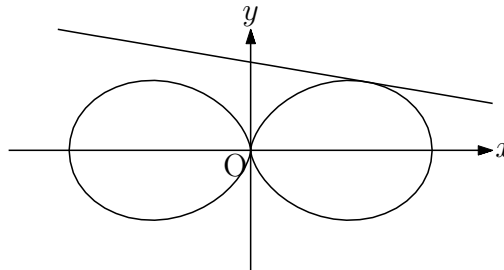

Example4

[⇒Command List](#)

## Mxbatch

**Usage** Mxbatch(filename)

**Description** Creation command to execute Maxima file

**Details** Create a command for CalcbyM to execute the file in ketcindy/ketlib/maximal. ketcindy/ketlib/maximal contains three files: fourier\_sec.max, matoperation.max and poincare.mac. For example, when dealing with Fourier series, use fourier\_sec.max.

### Examples

```

Setax(["a"]);
Slider("A-C-B", [-5.5, -1.5], [4.5, -1.5]);
defL=["1", [-3, -2], 1, "0", [-2, -1], 1, "-x", [-1, 1], 1, "0", [1, 2], 1, "-1", [2, 3], 1];
Drwxy();
tmp=Periodfun(defL, 1, ["dr, 2", "Color=red"]);
fun=tmp_1;
per=tmp_2;
Htickmark([1, "n", "1", 2, "n", "2", 3, "nw", "3"]);
Htickmark([-1, "-1", -2, "-2", -3, "-3"]);
cmdL=Concat(Mxbatch("fourier_sec"), [
  "Ffun(x):="+fun, [],
  "c:fourier_sec_coeff", ["Ffun(x)", "x"],
  "c[1]::c[2]::c[3]", []
]);
CalcbyM("ans", cmdL, []);
nterm=round(4*(C.x-A.x));
Fourierseries("1", ans, per, nterm, ["Num=400"]);
Mxtex("2", ans_3);
Expr([[-5, -2], "e", "s_n="+tx2, [4, -2], "e", "n="+text(nterm)]);

```

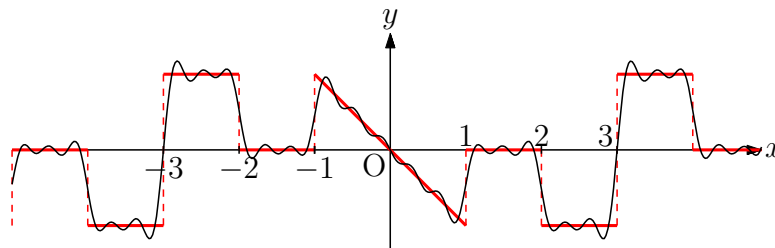

$$s_n = -\frac{2(\pi n \cos(\frac{2\pi n}{3}) + 3 \sin(\frac{\pi n}{3}) - \pi n \cos(\frac{\pi n}{3}) - \pi n (-1)^n)}{\pi^2 n^2} \quad n = 15$$

[⇒Command List](#)

## Mxfun

**Usage** Mxfun(name,formula,list,options)

**Description** Execution of Maxima's function

**Details** The second argument "formula" is Maxima's function name. The third argument "list" is a list of arguments to pass to the function.

The return value is a string if there is at least one character in the expression of the second argument. In the case of all numbers (including +, -, .), it becomes a number if it is 16 or less digits, and it becomes a string if it is more than 16 digits. Also, the return value is also assigned to the variable "mxname".

If "Disp = no" is added to the option, the result is not displayed on the console.

### Examples

```
Mxfun("1","taylor",["sin(x)","x",0,7],[""]);
Plotdata("1","sin(x)","x",["da"]);
Plotdata("2",mx1,"x");
```

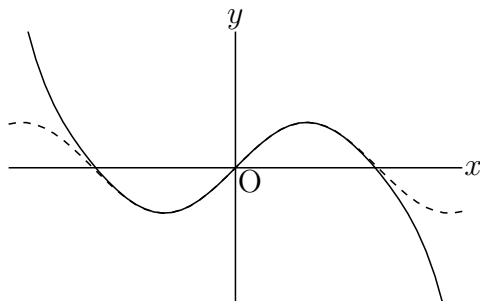

[⇒Command List](#)

## Mxtex

**Usage** Mxtex(name, formula)

**Description** Conversion of expression to TeX format

**Details** The second argument "formula" is the expression directly written or the return value of Mxfun. Convert it to TeX format.

The return value is also assigned to the variable "txname".

## Examples

### Example1

```
fx="x^3/((x+1)*(x+2))";
pfx=Mxfun("1","partfrac",[fx,"x"]);
form=Mxtex("1",fx)+"="+Mxtex("2",pfx);
dform=Assign(form,["frac","dfrac"]);
Expr([0,3],"e",form);
Expr([0,1],"e",dform);
```

$$\frac{x^3}{(x+1)(x+2)} = \frac{8}{x+2} - \frac{1}{x+1} + x - 3$$
$$x^3(x+1)(x+2) = 8x+2 - 1x+1 + x-3$$

Decomposition into partial fractions

$$\frac{x^3}{(x+1)(x+2)} = \frac{8}{x+2} - \frac{1}{x+1} + x - 3$$

### Example2

```
fx="x^2-x-3";
cmdL=[
  "ans:solve",[fx,"x"],
  "ans",[]
];
CalcbyM("ans",cmdL);
p1=indexof(ans,"[";
p2=indexof(ans,",");
p3=indexof(ans,"]");
s1=substring(ans,p1,p2-1);
s2=substring(ans,p2,p3-1);
s1=replace(s1,"x =", "");
s2=replace(s2,"x =", "");
Mxtex("1",s1);
Mxtex("2",s2);
Plotdata("1",fx,"x");
Expr([-2,-0.5],"e",tx1);
Expr([2,-0.5],"e",tx2);
```

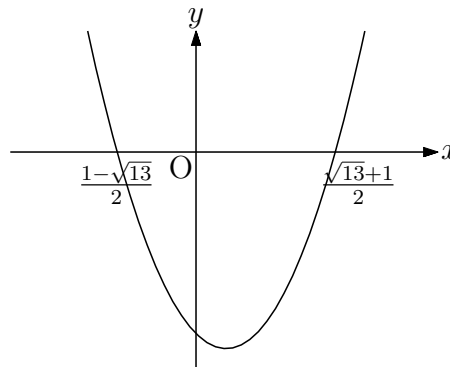

[⇒Command List](#)

## 2.3 Wolfram Engine

### CalcbyW

**Usage** CalcbyW(name, command,options)

**Description** To execute scripts of Wolfram Language(WL).

**Details** The second argument is a command to be executed by WL.

The result is assigned to the variable specified by "name", the value of the variable of

the command list last described (argument is the empty list). If you want to return more than one result, if you describe it by separating it with ":", it will be substituted into the list.

[⇒Command List](#)

## Wlfun

**Usage** Wlfun(name, formula, list,options)

**Description** To execution of a function of Wl.

If "Disp = no" is added to the option, the result is not displayed on the console.

[⇒Command List](#)

## Wltex

**Usage** Wltex(name, formula,options)

**Description** To convert expression to LaTeX format

**Details** The second argument "formula" is the expression directly written or the returned value of Wlfun or CalcbyW. The return value is also assigned to the variable "txname". If "Disp = no" is added to the option, the result is not displayed on the console.

[⇒Command List](#)

## 2.4 Risa/Asir

### CalcbyA

**Usage** CalcbyA(name, command,options)

**Description** Risa/Asir's script execution

**Details** The second argument is a command to be executed by Risa/Asir.

Create a list (eg. cmdL) consisting of a repetition of commands and argument lists, and execute at once.

There is no return value. The result (of undefined value) is assigned to the variable specified by "name", the value of the variable of the command list last described (argument is the empty list). If you want to return more than one result, if you describe it by separating it with ":", it will be substituted into the list.

[⇒Command List](#)

### Asirfun

**Usage** Asirfun(name, formula, list,options)

**Description** Execution of Risa/Asir's function

**Details** The second argument "formula" is the function name of Risa/Asir. The third argument "list" is a list of arguments to pass to the function.

The return value is a string if there is at least one character in the expression of the first argument. In case of all numbers (including +, -, .), it becomes a number if it is 16 digits or less, and it becomes a string if it is more than 16 digits. Also, the return value is also assigned to the variable "asname".

If "Disp = no" is added to the option, the result is not displayed on the console.

[⇒Command List](#)

## 2.5 MeshLab

Write next script in Initialization slot for use K<sub>F</sub>T Cindy 3D.

```
Ketinit();  
Ketinit3d();
```

### Mkobjcmd

**Usage** Mkobjcmd(name,formula,option)

**Description** generate commands for obj formatted files of surfaces without thickness.

#### Examples

```
fd=[ "z=x^2-y^2","x=[-1,1]","y=[-1,1]"," "];  
Sf3data("1",fd);  
Windispg();  
Mkobjcmd("1",fd,[40,40,"-"]);  
Meshlab():=(  
Mkviewobj("saddle",oc1, ["m","v"]);  
);
```

Option “+” is for the left figure, and “-” for the right.

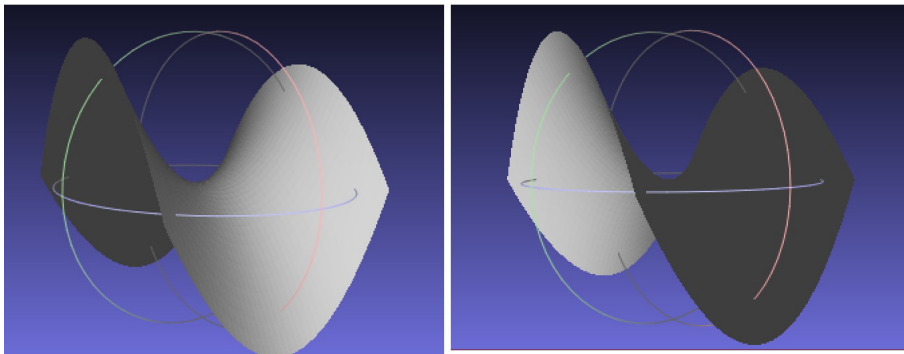

[⇒Command List](#)

### Mkobjcrvcmd

**Usage** Mkobjcrvcmd(name,PD,option)

**Description** generate commands for obj formatted files of spatial curves.

#### Examples

```
Spacecurve("1","[(6*pi-t)/(6*pi)*cos(t),(6*pi-t)/(6*pi)*sin(t),0.1*t]",  
"t=[0,6*pi]","Num=200");  
Windispg();  
Mkobjcrvcmd("1","sc3d1",[0.1,8,"yz"]);  
Meshlab():=(  
Mkviewobj("spiral",oc1,["m","v"]);  
);
```



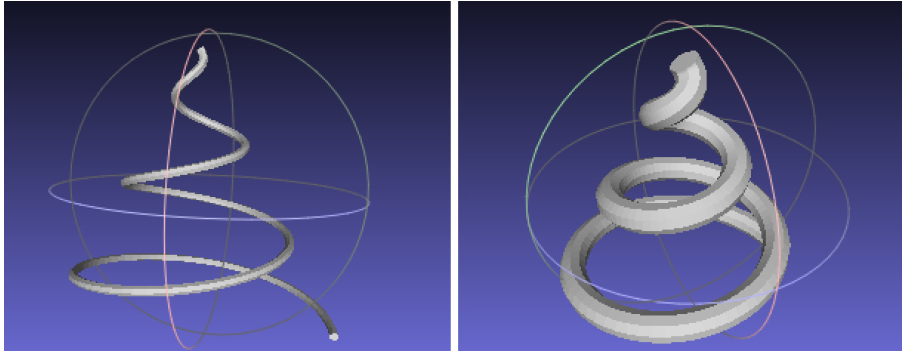

[⇒Command List](#)

## Mkobjnrm

**Usage** Mkobjnrm(name,formula)

**Description** calculate normal vector of surface.

**Details** Normal vector is calculated using the formula of surface.

### Examples

```
Mkobjnrm("1", "[x,y,x*y/sqrt(x^2+y^2)],x,y");
```

[⇒Command List](#)

## Mkobjplatecmd

**Usage** Mkobjplatecmd(name,facedata,options)

**Description** generate commands for obj formatted files of plates.

### Examples

```
Xyzax3data("", "x=[-5,5] ", "y=[-5,5] ", "z=[-5,5] ");
p1=[2,0,0];
p2=[0,2,0];
p3=[0,0,2];
plane=[[p1,p2,p3],[[1,2,3]]];
Mkobjplatecmd("1",plane,[0.05]);
Mkobjcrvcmd("2","ax3d");
Mkviewobj("plane",Concatcmd([oc1,oc2]),["m","v"]);
```

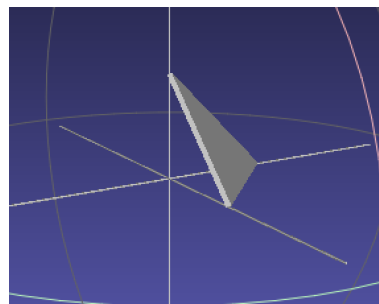

[⇒Command List](#)

## Mkobjpolycmd

**Usage** Mkobjpolycmd(name,PD,options)

**Description** generate commands for obj formatted files of polyhedra.

### Examples

```
Setdirectory(Dirhead+"/data/polyhedrons_obj");
polydt=Readobj("r01.obj",["size=-3.5"]);
Setdirectory(Dirwork);
pd=VertexEdgeFace("1",polydt,["Pt=fix","Edg=nogeo"]);
Mkobjpolycmd("1",pd,[[0,0,0]]);
Mkviewobj("plane",oc1,["m","v"]);
```

The polyhedron obj data is downloaded from

<http://mitani.cs.tsukuba.ac.jp/polyhedron/>

[⇒Command List](#)

## Mkobjsymbcmd

**Usage** Mkobjsymbcmd(PD,real,real,vector,vector)

**Description** generate commands for obj formatted files of some characters.

**Details** Plotting data are available for characters  $x$ ,  $y$ ,  $z$ ,  $t$ ,  $n$ ,  $P$ ,  $Q$ , and  $R$ . The arguments are their sizes, angles of rotations, directions of the viewpoints, positions.

### Examples

```
Mkobjsymbcmd("P",0.5,pi/3,[0,-1,0],[0,0,6]);
Mkobjsymbcmd("x",0.5,0,[0,-1,0],[6,0,0]);
Circledata("1",[[0,0],[1,0]],["nodisp"]);
Mkobjsymbcmd("cr1",0.5,0,[0,-1,0],[0,5,0]);
```

[⇒Command List](#)

## Mkobjthickcmd

**Usage** Mkobjthickcmd(name,formula)

**Description** generate commands for obj formatted files of surfaces with thickness.

### Examples

This function uses Maxima.

```
fd=[
"z=(x^2+y^2)",
"x=R*cos(T)","y=R*sin(T)",
"R=[0,2]","T=[0,2*pi]","e"
];
Mkobjthickcmd("1",fd,[40,40,0.2,"+n+s-e-w+","assume(R>0)"]);
Mkviewobj("pala",oc1,["m","v","Wait=5"]);
```

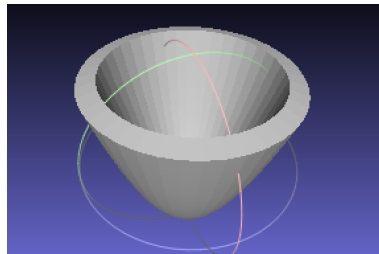

[⇒Command List](#)

## Mkviewobj

**Usage**            Mkviewobj(name,PD,options)

**Description**    generate obj formatted files.

**Details**            options

"m" or "make"	for generating data
"v" or "view"	for starting meshlab and viewing
"W=n" or "Wait=n"	for setting calculate time
"Unit=mm"	for setting unit of length

[⇒Command List](#)

### 3 Animation

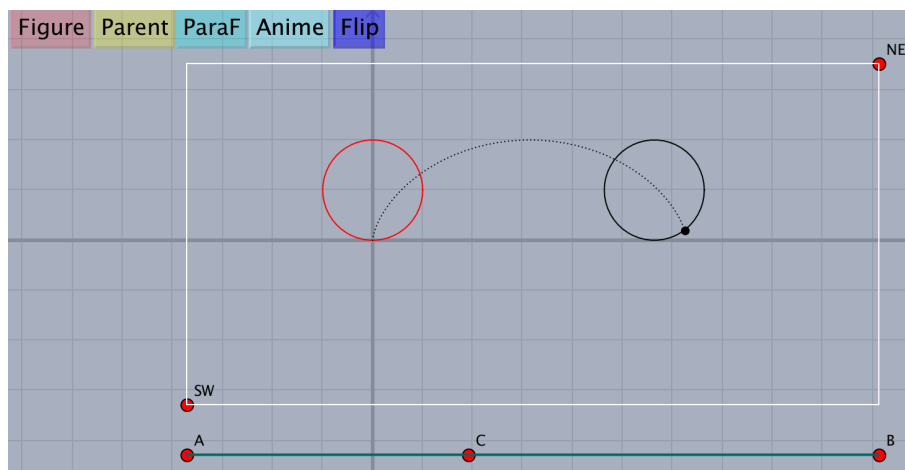

Operation of Buttons.

Figure	Viewtex();	Making figure.tex
Parent	same code	Making figure.pdf by Figpdf()
ParaF	Parafolder();	Making data folder of animation data
Anime	Mkanimation();	Making flip animation
Flip	Mkflipanime();	Making animation

#### Setpara

**Usage** Setpara(fname,funcstr,range,options1,options2)

**Description** Set up the animation control system.

**Details** "fname" is the name of output file. "funcstr" is the name of animation function. "range" is the range of parameter.

options1

m/r Remake the new data file / Reread the existing data file (default=r)  
 Div=n Total number of frames (default n=25).

options2

Frate=n Number of frames per second (default n=20)  
 Title=str Title  
 Scale=n Magnification factor of the figures  
 opA option for animate.sty  
 loop: loop, controls: Show control button, buttonsize  
 step: Mode of frame feed/frame retrun  
 Default is "OpA=[loop,controls,buttonsize=3mm]"  
 Use "+" then you can add a mode, for example "OpA+=step" then we have  
 "OpA=[loop,controls,buttonsize=3mm,step]"



## 4 $\text{K}_E\text{T}$ Cindy Slide

### Setslidebody

**Usage**            `Setslidebody(bodycolor,bodystyle,density)`

**Description**    Set up the color and density of the letters in slide body.

**Details**            Meanings and defaults of options are

<code>bodycolor</code>	color of letters	<code>"blue"</code>
<code>bodystyle</code>	style of letters	<code>"\Large\bf\boldmath"</code>
<code>density</code>	density of thin letters	0.1 (The range is from 0 to 1).

Remark : density can be changed by `\setthin{density}` in the text file.

[⇒Command List](#)

### Setslidehyper

**Usage**            `Setslidehyper("dvipdfmx",options)`

**Description**    Use `hyperref.sty`.

**Details**            if the 1st argument is null, it will be replaced with `"dvipdfmx"`.

options : `["cl=true,lc=blue,fc=blue","Pos=[125,73]","Size=1"]`

Meanings and defaults of options are

<code>"cl=..."</code>	colorlinks	<code>cl=true</code>
<code>"lc=..."</code>	linkcolor	<code>lc=blue</code>
<code>"fc=..."</code>	filecolor	<code>fc=blue</code>
<code>"Pos=..."</code>	start position of buttons	<code>"Pos=[125,73]"</code>
<code>"Size=..."</code>	size of buttons	<code>"Size=1"</code> .

[⇒Command List](#)

### Setslidemain

**Usage**            `Setslidemain([letterc,boxc,framec,xpos,size]);`

**Description**    Set up the main slide (a section delimiter).

**Details**            Meanings and defaults of options are

<code>letterc</code>	color of letters	<code>[0.98,0.13,0,0.43]</code>
<code>boxc</code>	color of box	<code>[0,0.32,0.52,0]</code>
<code>framec</code>	color of frame	<code>[0,0.32,0.52,0]</code>
<code>xpos</code>	horizontal position of title	62
<code>size</code>	magnification of title	2.

**Remark**            If some arguments are null, the default is used.

`Setslidemain(,,,3);`

[⇒Command List](#)

## Setslidepage

**Usage**            Setslidepage([letterc,boxc,framec,shadowc,xpos,size]);

**Description**    Set up each page of slides.

**Details**           Meanings and defaults of options are

letterc	color of letters	[0.98,0.13,0,0.43]
boxc	color of box	[0,0.32,0.52,0]
framec	color of frame	[0,0.32,0.52,0]
shadowc	color of shadow	[0,0,0,0.5]
xpos	horizontal position of title	6
size	magnification of title	1.3.

**Remark**           If some arguments are null, the default is used.

```
Setslidepage(, "red");
```

[⇒Command List](#)

## Setslidemargin

**Usage**            Setslidepage([leftmarginchange,topmarginchange]);

**Description**    This function changes the margin of slides from the default.

**Example**           Setslidemargin([+5,-10]);

[⇒Command List](#)

## Settitle

**Usage**            Settitle(list of title components,options)

**Description**    Make a title slide.

**Details**           Meanings and defaults of options are

"Title=..."	name of the title file	"Title=slide0"
"Layery=..."	starting vertical position	"Layery=0"
"Color=..."	color of letters	"Color=blue".

**Examples**

```
Settitle([
  "s{60}{20}{Main Title}",
  "s{60}{50}{Name}",
  "s{60}{60}{Affiliation}",
  "s{60}{70}{Info}"
],
["Title=SlideA","Color=[1,1,0,0]"]);
```

[⇒Command List](#)

# 5 KETCindy3D

## 5.1 Screen

The screen of KETCindy3D is structured as follows.

There are two areas surrounded by a white rectangle on the drawing surface of Cinderella. The area on the left side where the NE and the SW are diagonal is referred to as the main screen, and the area on the right side is referred to as the sub screen.

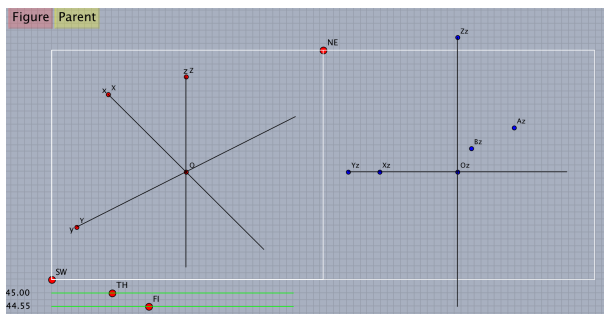

As in the case of a flat surface, the main screen shows the range output to TeX and it can be changed by dragging two points of NE and SW. The viewpoint can be moved with the slider below the main screen, and the axis rotates on the main screen. You can think of the sub screen as a viewpoint placed on the xy plane.

When you draw points and line segments with Cinderella's drawing tool on the main screen, points corresponding to the secondary screen are drawn. You can change the x, y coordinates by dragging the point on the main screen, and drag the point on the sub screen to change the z coordinate.

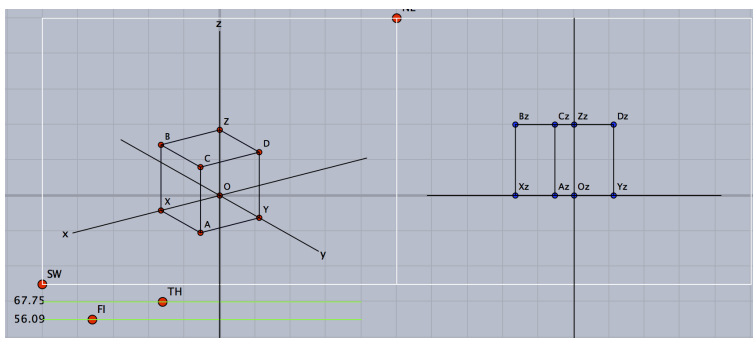

KeTCindy3D performs hidden line processing on lines and surfaces. Hidden line processing speeds up processing in cooperation with C language.

It is necessary to develop an environment that uses C language, but now it is standardized. If you can not use C language, you will use a function to compute with R, but in that case it will take quite a while.

## 5.2 Setting and Defining

### Ketinit3d

**Usage** Ketinit3d()

**Description** Declare the use of KeTCindy3D



**Details** Euclidean view of Cinderella becomes 3D mode. Two sliders are created to indicate the viewing angle  $TH(\theta)$ ,  $FI(\phi)$ . The initial values are  $TH = 0$  and  $FI = 0$ .

**Caution** This function and `Ketinit()` have to write on Initializaiton slot.

**Remark** If `Ketinit3d(0)` is used, the subscreen is not displayed. `Ketinit ()` is also placed in the Initialization Slot, unlike 2D.

[⇒Command List](#)

## Setangle

**Usage** `Setanlge(TH,FI)`

**Description** Specify rotation angle

**Details** Specify the TH and FI values of the slider that determines the rotation angle (position of the viewpoint).

For example, if you set `Setangle (70,40)` , then TH and FI are in that position. Since the slider is fixed, if you want to activate the slider again, comment it and re-execute it.

If you want to decide only the initial state

```
if (!Ptselected (), Setangle (70, 40));
```

or

```
if (!Isangle (), Setangle (70, 40));
```

The slider becomes effective.

If any point on the slider is selected, the figure button is also valid. Click anywhere on the screen and return to the original if you deselect the point selection state.

[⇒Command List](#)

## Getangle

**Usage** `Getanlge()`

**Description** Acquire rotation angle

**Details** Acquires the rotation angle (viewpoint position) TH and FI that can be set with the slider. This is the value displayed on the left side of the slider. The return value is the list [TH, FI], and the angle is expressed by the Degree measure. In addition, the internal variables are THETA and PHI, expressed in circular measure.

[⇒Command List](#)

## Start3d

**Usage** `Start3d(option)`

**Description** 3d function to initialize limited variables.

**Details** This function should be written at the beginning of Draw slot.

The option is a list of geometric points which are not regarded as 3D points.

**Example**

If option is given a list of exclusion points, that point is not a point of space. (The position does not change even if moving the viewpoint with the slider)

```
Start3d([A,B,C]);
```

```
Slider("A-C-B"); // A,C,B should not be 3D points.
```

## Startsurf

**Usage** Startsurf(options)

**Description** Defines values related to surface rendering.

**Details** Values are number to divide, size of C, limit of error. Omitted options selects [50,50],[1500,500,200],[0.01,0.1].

Drawing of a curved surface with hidden line processing is performed in the following procedure.

- (1) Startsurf();
- (2) Making data with draw function.
- (3) Draws shapes in batch in C language using function ExeccmdC();.

[⇒Command List](#)

## Xyzax3data

**Usage** Xyzax3data(name, range of x, range of y, range of z, options)

**Description** Generic function to draw the coordinate axis.

**Details** Name can be null string.

Options are the followings.

"an": arrowhead, n is size.

"Onesw": origin and its position.

### Examples

```
Xyzax3data("", "x=[-5,5] ", "y=[-5,5] ", "z=[-5,5] ");  
Xyzax3data("", "x=[-5,5] ", "y=[-5,5] ", "z=[-5,5] ", "a"); //arrowhead  
Xyzax3data("", "x=[-5,5] ", "y=[-5,5] ", "z=[-5,5] ", ["a2"]); //big arrowhead  
Xyzax3data("", "x=[-5,5] ", "y=[-5,5] ", "z=[-5,5] ", ["0"]);  
Xyzax3data("", "x=[-5,5] ", "y=[-5,5] ", "z=[-5,5] ", ["a", "0e2n2"]); //set origin up-  
per right
```

[⇒Command List](#)

## 5.3 Command for Drawing

### 5.3.1 Point and line

#### Drawpoint3d

**Usage** Drawpoint3d(list of coordinates)

**Description** Generic function to draw 3D-points.

**Details** These points are not geometric point. To convert the geometric point, use [Putpoint3d\(\)](#). To output in the T<sub>E</sub>Xfile, use [Pointdata\(\)](#) or [Drawpoint\(\)](#).

#### Examples

```
Drawpoint3d([1,1,1]);  
Drawpoint3d([[1,1,1],[0,1,0]]);
```

**Remark** [Comparative chart of drawing of points](#)

[⇒Command List](#)

#### Pointdata3d

**Usage** Pointdata3d(name, point list, options)

**Description** Generic function to generate data of the point list.

**Details** Options are "Size=", "Color=".

**Examples** Pointdata3d("1", [[0,1,0],[1,1,2]], ["Size=2", "Color=red"]);

[⇒Command List](#)

#### Putpoint3d

**Usage** Putpoint3d(list of 3D-points, option)

**Description** Generic function to draw the geometric point in the space.

**Details** Option is "free" or "fix"(default).

#### Examples

```
Putpoint3d(["A", [2,1,3]]);  
Putpoint3d(["A", [2,1,3], "free"]);  
Putpoint3d(["A", [1,1,1], "C", [1,0,1]]);
```

These points don't output in the T<sub>E</sub>Xfile. To output in the T<sub>E</sub>Xfile use the following [Pointdata\(\)](#) or [Drawpoint\(\)](#)

In the 3D-drawings the coordinate of the point name A is A3d.

**Remark** [Comparative chart of drawing of points](#)

[⇒Command List](#)

#### Putaxes3d

**Usage** Putaxes3d([x,y,z])

**Description** Generic function to make the geometric points on the coordinate axis.

**Details** For the argument [x,y,x] we get the four geometric points X(x,0,0), Y(0,y,0), Z(0,0,z) and O(0,0,0).

### Examples

```
Putaxes3d([1,2,3]);  
Putaxes3d(a); //this equals to Putaxes3d([a,a,a]);
```

[⇒Command List](#)

## PutonCurve3d

**Usage** PutonCurve3d(name, PD)

**Description** Generic function to make the geometric point on the 3D-curve.

**Details** This point moves along the curve by mouse dragging.

### Examples

Make reference to [Partcrv3d\(\)](#)

[⇒Command List](#)

## Putonseg3d

**Usage** Putonseg3d(name, point1, point2)

**Description** Generic function to make the geometric point on the 3D-segment.

**Details** We get the middle point between the two points. This point moves along the segment by mouse dragging.

### Examples

```
Putonseg3d("C",A,B); //Put C on the center of A and B.  
Putonseg3d("C", [A,B]); //same as above
```

[⇒Command List](#)

## Spaceline

**Usage** Spaceline(name, list)

**Description** Generic function to draw the space polygonal lines.

**Details** Options are line type: "dr" or "da" or "do".

### Examples

```
Spaceline("1", [[2,5,1], [4,2,3]]); //draw the line between two points  
Spaceline("2", [A,B,C,A]); //draw the triangle ABC  
pt=[[2,0,0], [2,0,2], [2,2,2], [0,2,2], [0,4,2], [0,4,4]];  
Spaceline("1",pt);  
Pointdata3d("1",pt, ["Size=3"]);
```

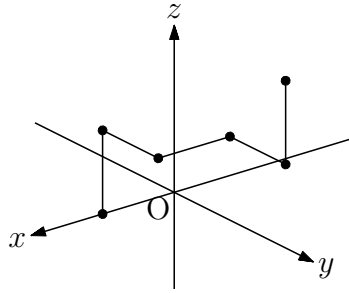

[⇒Command List](#)

## Spacecurve

**Usage** Spacecurve(name, formula, domain, options)

**Description** Generic function to draw the space curve.

**Examples** `Spacecurve("1", "[2*cos(t), 2*sin(t), 0.2*t]", "t=[0, 4*pi]", ["Num=100"]);`  
 option=["Num=100"]: division number of the interval "t=[0, 4\*pi]"

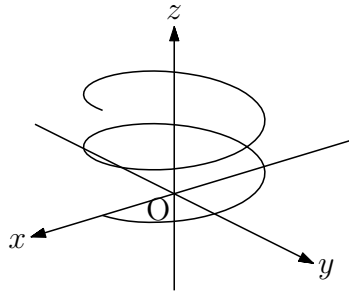

[⇒Command List](#)

## Bezier3d

**Usage** Bezier3d(name, list1, list2)

**Description** Draw a Cubic Bézier curve.

**Details** list1 is list of anchor points, and list2 is list of handle points

**Examples**

`Bezier3d("1", ["A", "B", "C"], ["D", "E", "F", "G"]);`

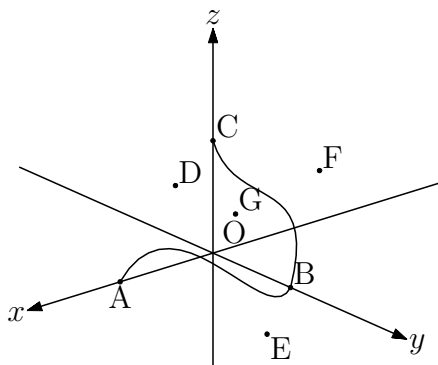

## Mkbezierptcrv3d

**Usage** Mkbezierptcrv3d(list)

**Description** Draw a cubic Bézier curve from nodes.

**Details** Arrange the control points automatically. After that, move the nodes and the control points and correct the cubic Bézier curve to what you want to draw. See the function [Bezier3d](#).

### Examples

```
Mkbezierptcrv3d(["A","B","C","D"]);
```

⇒Command List

## Skeletonparadata

**Usage** Skeletonparadata(name, PDlist, PDlist, option)

**Description** Generic function to draw the lines by performing hidden line processing.

**Details** This function draw the second argument(the list of the lines) by performing hidden line processing which are hidden by the third argument(the list of the lines). If both arguments are omitted the function draw all lines by performing hidden line processing.

Options:

real number gap of line

"No=pointlist" not executed when any point is selected

"File=y/m/n(default:n)" whether to make data file or not

"Check=pointlist" data file updated if any point is changed

### Examples

```
Xyzax3data("", "x=[-5,5]", "y=[-5,4]", "z=[-5,3]"); //Data name is "ax3d".
Putpoint3d(["A", [0,-2,-2]]);
Putpoint3d(["B", [-1,1,3]]);
Spaceline([A,B]); //Data name is "AB3d".
Spacecurve("1", "[2*cos(t), 2*sin(t), 0.2*t]", "t=[0,4*pi]", ["Num=100"]); //Data
name is "sc3d1".
```

```
Skeletonparadata("1"); //(left figure)
```

```
Skeletonparadata("1", [2]); //option=[2]: gap of lines=2 (center figure)
```

```
Skeletonparadata("1", ["AB3d", "ax3d"], ["sc3d1"]); //(right figure)
```

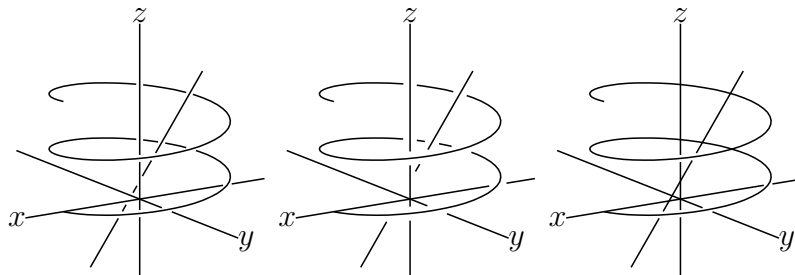

⇒Command List

### 5.3.2 Polyhedron

The description of polyhedron drawing will be explained by taking the case of tetrahedron as an example.

The tetrahedron is composed of four sides. Letting the vertices be A, B, C, D, the four faces are

$$\triangle ABC, \triangle ABD, \triangle ACD, \triangle BCD$$

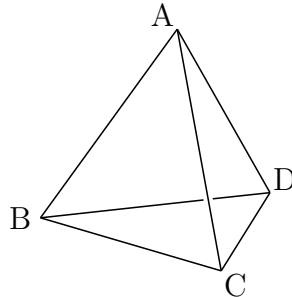

If numbers are given to the vertex list [A, B, C, D] in order from A, the vertex order of each face is [1, 2, 3], [1, 2, 4], [1, 3, 4], [2, 3, 4].

[A, B, C, D], [[1, 2, 3], [1, 2, 4], [1, 3, 4], [2, 3, 4]] is called "surface data". VertexEdgeFace () draws a polyhedron using this surface data.

There are two kinds of hidden line processing of polyhedron. The first method is to treat polyhedron as a line drawing, and to process only the hidden part, using Skeletonparadata ().

The other is to use Phparadata () as a way to draw a part hidden in the surface with a dotted line or hide it, considering it as a surface.

## Concatobj

**Usage** Concatobj(list,options)

**Description** Concatenates several objects.

### Examples

A tetrahedron by four vertecies A,B,C,D.

The tetrahedron consists of four planes  $\triangle ABC$ ,  $\triangle ABD$ ,  $\triangle ACD$ ,  $\triangle BCD$ .

```
Putpoint3d("A",2*[0,0,sqrt(3)]);
Putpoint3d("B",2*[1,-1/sqrt(3),0]);
Putpoint3d("C",2*[0,sqrt(3)-1/sqrt(3),0]);
Putpoint3d("D",2*[-1,-1/sqrt(3),0]);
phd=Concatobj([ [A,B,C], [A,B,D], [A,C,D], [B,C,D] ]);
VertexEdgeFace("1",phd);
Skeletonparadata("1");
Letter3d([A3d,"ne","A",B3d,"sw","B",C3d,"se","C",D3d,"e","D"]);
```

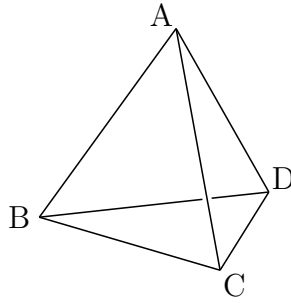

If you are drawing tetrahedrons without creating geometric points, you can do as follows.

```
a=2*[-1,-1/sqrt(3),0];
b=2*[1,-1/sqrt(3),0];
c=2*[0,sqrt(3)-1/sqrt(3),0];
d=2*[0,0,sqrt(3)];
phd=Concatobj([[a,b,c],[a,b,d],[a,c,d],[b,c,d]]);
```

In the case of a convex polygon such as a tetrahedron, we can use CindyScript's `convexhull3d()` function as follows. You can save time and effort by simply providing a vertex list instead of a surface list.

```
a=2*[0,0,sqrt(3)];
b=2*[1,-1/sqrt(3),0];
c=2*[0,sqrt(3)-1/sqrt(3),0];
d=2*[-1,-1/sqrt(3),0];
phd=convexhull3d([a,b,c,d]);
```

[⇒Command List](#)

## Vertexedgeface

**Usage** VertexEdgeFace(name, list, options)

**Description** Generic function to draw the polyhedron.

**Details** We use the faces data of the polyhedron.

The second argument is the list of vertexes list and the faces list.

For example, the faces data of the tetrahedron is `[[A,B,C,D],[[1,2,3],[1,2,4],[1,3,4],[2,3,4]]]`.

The generated data is as follows.

phv3d: list of vertices

phe3d: list of edges

phf3d: Surface list

Each name is appended to the end.

### Examples

```
Putpoint3d("A",2*[-1,-1/sqrt(3),0]);
Putpoint3d("B",2*[1,-1/sqrt(3),0]);
Putpoint3d("C",2*[0,sqrt(3)-1/sqrt(3),0]);
Putpoint3d("D",2*[0,0,sqrt(3)]);
```



```

phd=[[A,B,C,D],[[1,2,3],[1,2,4],[1,3,4],[2,3,4]]];
VertexEdgeFace("1",phd);
//Three data lists are made, phv3d1:vertex, phe3d1:edge and phf3d1:face.

```

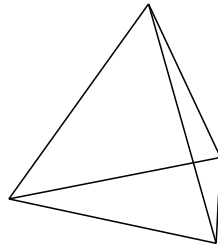

[⇒Command List](#)

## Phparadata

**Usage** Phparadata(name, name2, list of options)

**Description** Generic function to draw the polyhedron by performing hidden line processing.

**Details** Make polyhedral plot data with VertexEdgeFace (). For this plot data, hidden surfaces (sides) are hidden-line processed and displayed. The second argument name2 is the same as the name given by VertexEdgeFace (). The hidden line type is specified by the option "Hidden = line type". Hidden lines are not displayed by default setting.

### Examples

To draw a tetrahedron,

```

Putpoint3d("A",2*[-1,-1/sqrt(3),0]);
Putpoint3d("B",2*[1,-1/sqrt(3),0]);
Putpoint3d("C",2*[0,sqrt(3)-1/sqrt(3),0]);
Putpoint3d("D",2*[0,0,sqrt(3)]);
phd=Concatobj([[A,B,C],[A,B,D],[A,C,D],[B,C,D]]);
VertexEdgeFace("1",phd);
Phparadata("1","1",["Hidden=do"]);

```

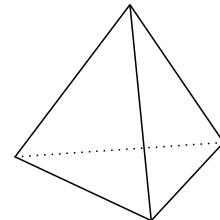

A tetrahedron is drawn by VertexEdgeFace (), but it is hidden by Phparadata (). Since it is correctly output if it is drawn with the figure button, it is good to execute Phparadata () after confirming it by displaying it on the screen before executing Phparadata ().

Draw a truncated icosahedron of s06 (soccer ball type) using polyhedron data polyhedrons\_obj by Kobayashi, Suzuki, Mitani.

```

Setdirectory( Dirhead+"/data/polyhedrons_obj"); //Many polyhedron data exist
in this directory.
phd=Readobj("s06.obj",["size=3"]); //"s06" is the name of truncated icosahedron
data.
Setdirectory(Dirwork); //Chage work space.
VertexEdgeFace("s06",phd);

```

```
Phparadata("1","s06"); //default usage, left figure
```

The last two lines we can write the following.

```
VertexEdgeFace("1",phd);
Phparadata("1","1");
```

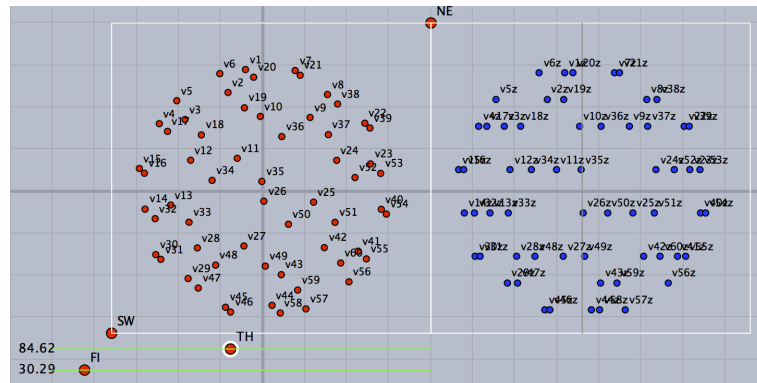

```
Phparadata("1","s06",["dr,2","Hidden=do"]); //right figure
```

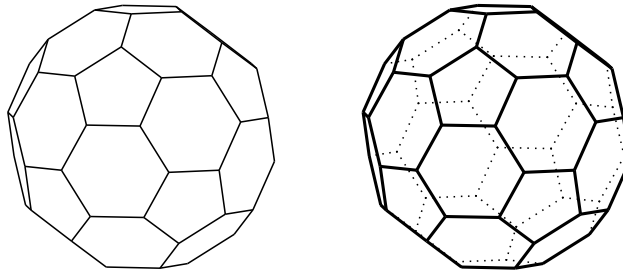

[⇒Command List](#)

## Nohiddenbyfaces

**Usage** Nohiddenbyfaces(name,PD1,PD2,option1,option2)

**Description** Generic function to draw hidden lines by the surfaces.

**Details** PD1 are hidden lines, PD2 are surfaces.

If we omit PD1 then all lines are processing objects.

By default, hidden lines are drawn with dotted lines.

Option1=line type of PD2 and option2=line type of hidden lines.

If we specify only option2 then option1 must be null list:[].

## Examples

```
XYZax3data("", "x=[-5,5]", "y=[-5,5]", "z=[-5,4]");
Putpoint3d("A", 2*[-1, -1/sqrt(3), 0]);
Putpoint3d("B", 2*[1, -1/sqrt(3), 0]);
Putpoint3d("C", 2*[0, sqrt(3)-1/sqrt(3), 0]);
Putpoint3d("D", 2*[0, 0, 2*sqrt(6)/3]);
phd=Concatobj([ [A,B,C], [A,B,D], [A,C,D], [B,C,D] ]);
VertexEdgeFace("1", phd);
Nohiddenbyfaces("1", "phf3d1");
```

(left figure)

`Nohiddenbyfaces("1","phe3d1","phf3d1",["dr,2"],["da"]);` (right figure)

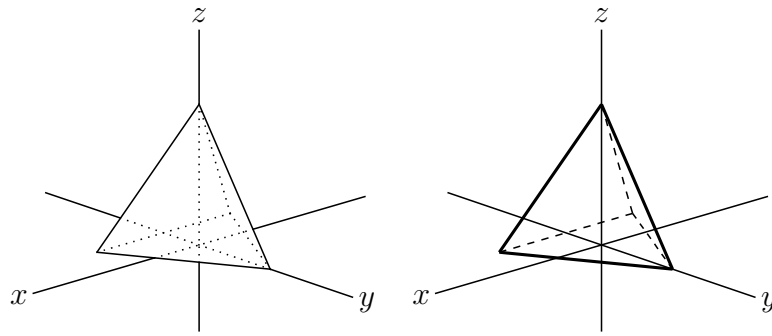

We draw hidden axes with broken line in the following example.

`Nohiddenbyfaces("1","ax3d","phf3d1",[],["da"]);`

[⇒Command List](#)

### 5.3.3 Surface

There are wire frame models and surface models for drawing curved surfaces. The wire frame model represents a curved surface with stitches, and the surface model draws its contour as a stitch-free surface.

In KeTCindy, each drawing is done using the following function.

Wire frame model without hidden wire	<code>Sf3data(name,form,options)</code>
Surface model	<code>Sfbdparadata(name,form,options)</code>
Hidden-line wireframe model	<code>Wireparadata(name,PD,form,n1,n2,options)</code>

However, in order to do hidden line processing, surface data is necessary, so after drawing with `Sfbdparadata()`, draw hidden lines with `ireparadata()`.

Also, in the drawing of the surface model, it takes time to process the hidden line, so it is assumed to use the C language. Therefore, `ExeccmdC()` which draws using C language is used together.

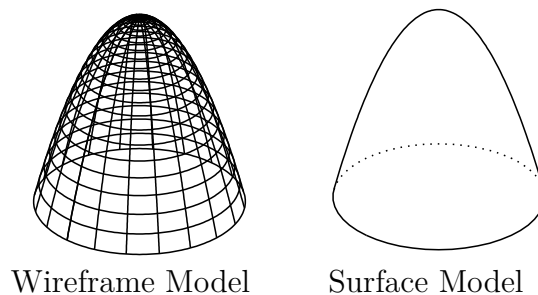

The form of the argument is an equation and a list of character strings for the domain of the variable. There are three patterns of equations as follows.

- (1)  $z = f(x, y)$   
 Example formula :  $z = x^2 - y^2$   
 range :  $x = (-2, 2), y = (-2, 2)$
- (2)  $z = f(x, y), x = g(r, t), y = h(r, t)$

Example formula :  $z = 4 - (x^2 + y^2), x = r \cos t, y = r \sin t$   
 range :  $r = (0, 2), t = (0, 2\pi)$   
 (3)  $x = f(u, v), y = g(u, v), z = h(u, v),$   
 Example formula :  $x = 2 \sin u \cos v, y = 2 \sin u \sin v, z = 2 \cos u$   
 range :  $u = (0, \pi), v = (0, 2\pi)$

Here, (2) and (3) are parametric types, each consisting of expressions of  $x, y, z$  and two domain of parametric variables. Since it is indistinguishable as it is, when giving it as an argument, "p" is added to the type of (3) as the identification character at the beginning.

Regarding the domain of definition, there are cases where it is taken in the open section and in the closed section. The distinction is indicated by "ewsn" as boundary designation (both are closed segments). I think the meaning of "ewsn" as follows.

For variable  $u, v, a \leq u \leq b, c \leq v \leq d$

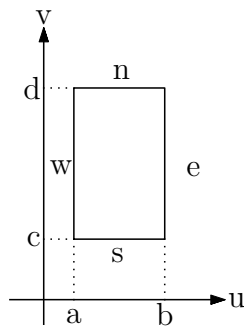

This boundary designation is added at the end, but it can be omitted, and if omitted, it is the initial value "ewsn" (closed interval).

To make both open segments, add "". However, do not perform hidden line processing Sf3data () draws a line also on the boundary, so you can omit this specification.

```
fd=["p", "x=r*cos(t)", "y=r*sin(t)", "z=2*(2-r)", "r=[1,2]", "t=[0,2*pi]", "ew"]
```

If this is "e",  $1 < r \leq 2$  is obtained, and the top face is not displayed.

Also, if this is set to "w",  $1 \leq r < 2$  and the bottom is not displayed.

Furthermore, if you specify "ewn" or "ews" or abbreviate the initial value "ewsn", it will contain either the left or right value of  $t = (0, 2\pi)$ , A border appears.

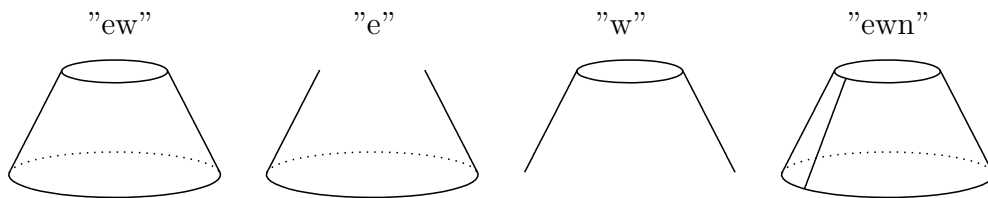

### Sf3data

**Usage** Sf3data(name, list, list of options)

**Description** Generic function to draw the wire frame model of the surface.

**Details** Second argument is the list of equations and ranges.

Options are the followings.

"Num=[a,b]": x- and y-division number, default(or initial values) are a=b=25.

"Wire=[a,b]": x- and y-wire number, default(or initial values) are a=b=20.

"ewsn": From east to south, this indicates the boundary.

## Examples

```
Sf3data("1", ["z=x^2-y^2", "x=[-2,2]", "y=[-2,2]"]);
```

//This is the first expression of the equation for the surface. Second argument is the list of equation, x-range and y-range.

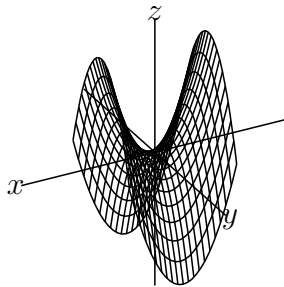

```
fd=["z=4-(x^2+y^2)", "x=R*cos(T)", "y=R*sin(T)", "R=[0,2]", "T=[0,2*pi]"];  
Sf3data("1",fd); //fd is the second argument.
```

(left figure)

```
fd=["z=sin(sqrt(abs(x^2+y^2)))", "x=r*cos(t)", "y=r*sin(t)",  
"r=[0,3]", "t=[0,2*pi]"];
```

```
Sf3data("1",fd);
```

(right figure)

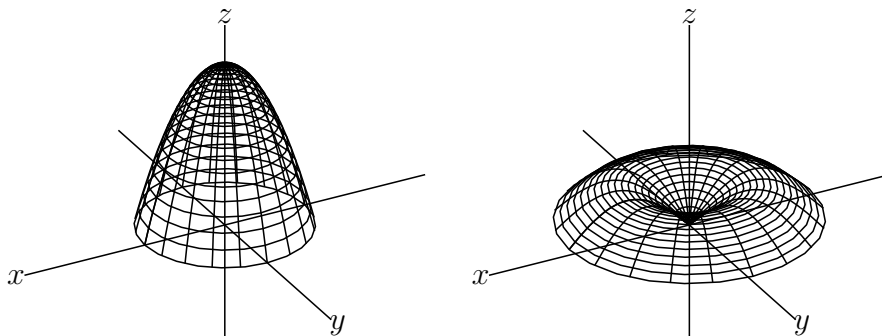

```
fd=["p", "x=2*sin(u)*cos(v)", "y=2*sin(u)*sin(v)", "z=2*cos(u)",  
"u=[0,pi]", "v=[0,2*pi]"]; // "p" indicates the 3D-parameter expression.
```

```
Sf3data("1",fd);
```

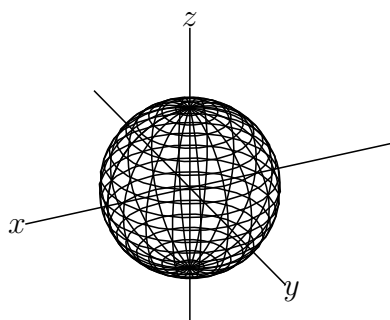

## Sfbdparadata

**Usage** Sfbdparadata(name, list, list of options)

**Description** Generic function to make the surface by performing hidden line processing.

**Details** Second argument is the list of equations and ranges same as the function "Sf3data".

options1=no option or " "(space) or "r" or "m" and "Wait=integer". Default value of Wait is 20.

No option or " "(space) means

(1) If there exist no deta then it make a new data file.

(2) If there exist deta then it read the data file.

"m" means that it remake the new data file.

"r" means that it reread the existing data file.

option2="nodisp" or line type of hidden line. Default is "nodisp".

If we specify only option2 then we denote that option1 is empty list:[].

⇒Command List

## ExeccmdC

**Usage** ExeccmdC(name,options1,options2)

**Description** Generic function to draw 3D-surface. The return value is the list of processed plot data.

**Details** options1=no option or " "(space) or "r" or "m" and "Wait=integer" , line type.

Default value of Wait is 20.

No option or " "(space) means

(1) If there exist no deta then it make a new data file.

(2) If there exist deta then it read the data file.

"m" means that it remake the new data file.

"r" means that it reread the existing data file.

option2="nodisp" or line type of hidden line. Default is "do".

If we specify only option2 then we denote that option1 is empty list:[].

### Examples

Hidden lines are not shown or shown.

```
fd=["z=x^2-y^2", "x=[-2,2]", "y=[-2,2]"];
if(Isangle(),
  Sf3data("1",fd);
  ,
  Startsurf();
  Sfbdparadata("1",fd,[],["nodisp"]); // Change "nodisp" to "do"
  ExeccmdC("1"));
);
```

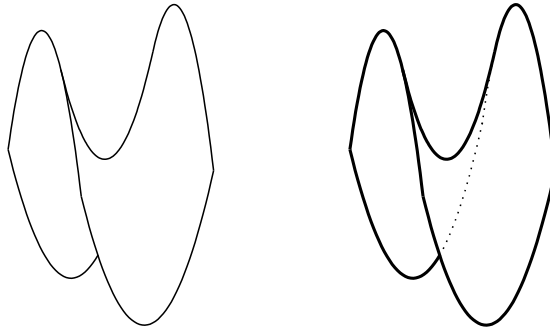

Make the whole thick with a solid line and display the hidden line with a dotted line (Default).

```
ExeccmdC("1", ["dr,2"]);
```

Paraboloid

```
fd=["z=4-(x^2+y^2)", "x=R*cos(T)", "y=R*sin(T)", "R=[0,2]", "T=[0,2*pi]", "e"];
```

Delete hidden line ( left figure) `ExeccmdC("1", [], ["nodisp"]);`

Hidden lines are indicated by broken lines ( right figure ) `ExeccmdC("1", [], ["da"]);`

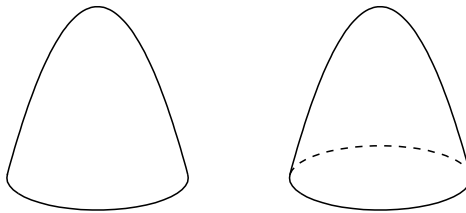

When displaying two curved surfaces, name of `Sfbdparadata ()` is set to "1" and "2", but it can be displayed together as `ExeccmdC ("1")` .

```
fd=[
  "p",
  "x=r*cos(t)", "y=r*sin(t)", "z=2*(2-r)",
  "r=[1,2]", "t=[0,2*pi]", "ew"
];
fd2=[
  "p",
  "x=r*cos(t)-3", "y=r*sin(t)+3", "z=2*(2-r)",
  "r=[0,2]", "t=[0,2*pi]", "ew"
];
if(!ptselected(),
  Startsurf();
  Sfbdparadata("1",fd);
  Sfbdparadata("2",fd2);
  ExeccmdC("1");
);
```

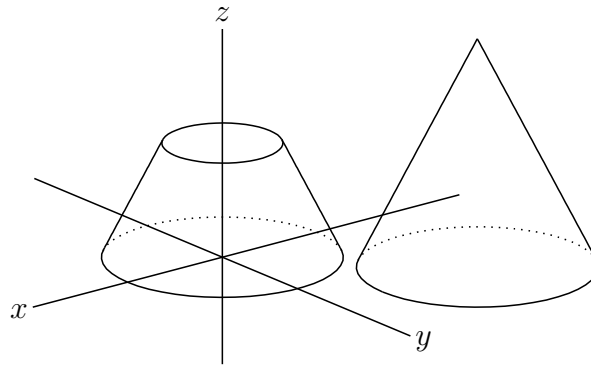

```
fd=["p", "x=(2+cos(u))*cos(v)", "y=(2+cos(u))*sin(v)", "z=sin(u)",
    "u=[0,2*pi]", "v=[0,2*pi]", "s"];
if(Ptselected(),
    Sf3data("1",fd);
,
    Startsurf();
    Sfbdparadata("1",fd);
    Wireparadata("1","sfbd3d1",fd,12,12,[],["nodisp"]);
    ExeccmdC("1",[],["nodisp"]);
);
```

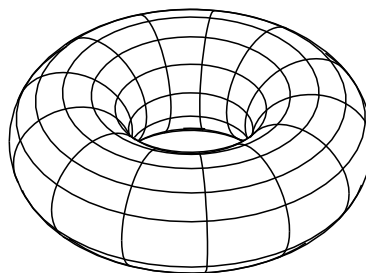

[⇒Command List](#)

## Wireparadata

**Usage** Wireparadata(name, PD, formula, integer, integer, options)

**Description** Generic function to draw the surface by wire frame data with performing hidden line processing.

**Details** The second argument PD is the surface data made by Sfbdparadata function. options=no option or " "(space) or "r" or "m" and "Wait=integer". Default value of Wait is 30.

No option or " "(space) means

(1) If there exist no deta then it make a new data file.

(2) If there exist deta then it read the data file.

"m" means that it remake the new data file.

"r" means that it reread the existing data file.



## Examples

```
fd=["z=x^2-y^2","x=[-2,2]","y=[-2,2]"];
if(Isangle(),
  Sf3data("1",fd);
,
Startsurf();
Sfbdparadata("1",fd); //We get the data named as "sfbd3d1".
Wireparadata("1","sfbd3d1",fd,4,5,[""]); //number of wires are 4 and 5.
ExeccmdC("1"); //draw the wires
);
```

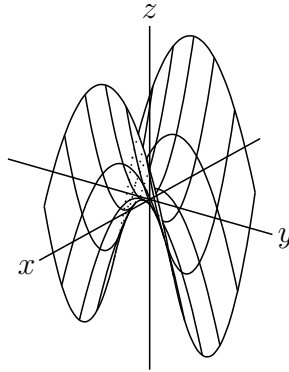

Change the following code.

```
fd=["z=4-(x^2+y^2)","x=r*cos(t)","y=r*sin(t)","r=[0,2]","t=[0,2*pi]","e"];
Wireparadata("1","sfbd3d1",fd,5,7,[""]);
```

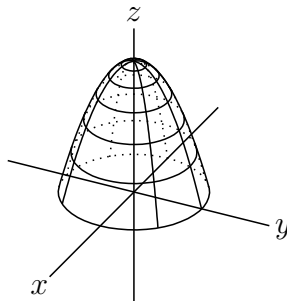

```
fd=["p","x=2*sin(u)*cos(v)","y=2*sin(u)*sin(v)","z=2*cos(u)","u=[0,pi]","v=[0,2*pi]","s"];
if(Ptselected(),
  Sf3data("1",fd);
,
Startsurf();
Sfbdparadata("1",fd);
Wireparadata("1","sfbd3d1",fd,12,12);
ExeccmdC("1");
);
```

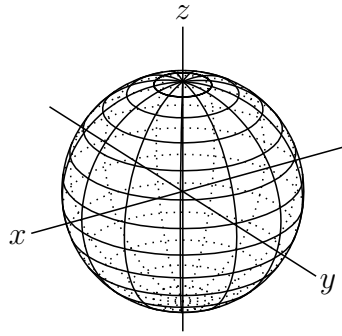

```

fd=["p","x=2*sin(u)*cos(v)","y=2*sin(u)*sin(v)","z=2*cos(u)","u=[0,pi] ",
    "v=[0,2*pi]","s"];
if(Isangle(),
    Sf3data("1",fd);
,
Startsurf();
Sfbdparadata("1",fd);
Wireparadata("1","sfb3d1",fd,12,12,[""]);
Crvsfparadata("1","ax3d","sfb3d1",fd);
ret=ExeccmdC("1");
forall(1..length(ret),
    if(indexof(ret_#,"wireh")>0,
        Changestyle3d([ret_#],["nodisp"]);
    );
);
);

```

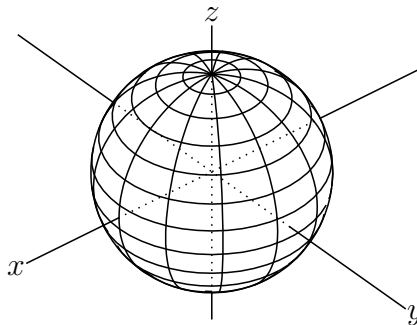

[⇒Command List](#)

## Crvsfparadata

**Usage** Crvsfparadata(name,PD1,PD2,formula)

**Description** Remove curves hidden by curved face.

### Examples

left figure

```

Xyzax3data("", "x=[-5,5]","y=[-5,5]","z=[-5,5]");
Putpoint3d(["A",[0,-3,0],"B",[0,3,3]]);
Spaceline([A,B]);

```

```
fd=["z=4-(x^2+y^2)", "x=R*cos(T)", "y=R*sin(T)", "R=[0,2]", "T=[0,2*pi]", "e"];
Startsurf();
Sfbdparadata("1",fd);
Crvsfparadata("1","AB3d","sfbd3d1",fd);
Crvsfparadata("2","ax3d","sfbd3d1",fd);
ExeccmdC("1");
```

right figure

```
ExeccmdC("1", [], ["nodisp"]);
```

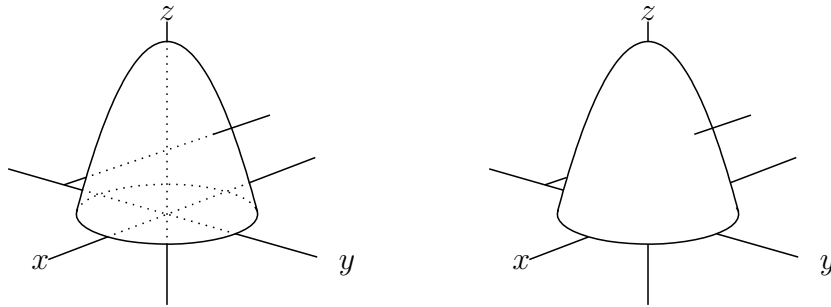

By using the return value, you can change the hidden line style (line style, color). The same as the return value is displayed as "readoutdata from template3D1.txt:" on the console, so you can decide the operation target by looking at it. For example, in the left diagram above, the hidden line of line AB is the fourth crvsfh3d1 in the list, so you can make it a red dashed line as follows.

```
ret=ExeccmdC("1");
Changestyle3d(ret_4, ["da", "Color=red"]);
```

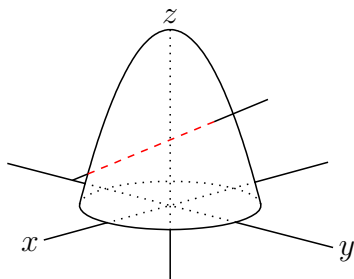

[⇒Command List](#)

## 5.4 Using Plot data

### Datalist2d

**Usage** Datalist2d()

**Description** Generic function to get a list of 2D-plotting data on the screen.

#### Examples

We execute the following program then the computer will display "PD=[ax2d,AB2d]" on the console.

```
Xyzax3data("", "x=[-5,5]", "y=[-5,5]", "z=[-5,5]");
Putpoint3d(["A", [0,-3,0], "B", [0,3,3]]);
```

```
Spaceline("1", [A,B]);
println("PD="+Datalist2d());
```

[⇒Command List](#)

## Datalist3d

**Usage** Datalist3d()

**Details** Generic function to get a list of 3D-plotting data.

### Examples

We execute the following program then the computer will display "PD=[ax3d,AB3d]" on the console.

```
Xyzax3data("", "x=[-5,5]", "y=[-5,5]", "z=[-5,5]");
Putpoint3d(["A", [0,-3,0], "B", [0,3,3]]);
Spaceline("1", [A,B]);
println("PD="+Datalist3d());
```

[⇒Command List](#)

## Changestyle3d

**Usage** Changestyle3d(PD,option)

**Description** Change the attribute of PD.

**Details** Change the attribute of PD to one with option specification. PD is a plotting data or a list of plotting data.

### Examples

Make a tetrahedron by four points of space.

```
Spaceline("1", [A,B]);
Spaceline("2", [A,C]);
Spaceline("3", [B,C]);
Spaceline("4", [A,D]);
Spaceline("5", [B,D]);
Spaceline("6", [C,D]);
then
Changestyle3d("s13d1", ["dr,3"]); // one edge become thick.
or
edges=apply(1..6, "s13d"+text(#));
Changestyle3d(edges, ["notex"]); // all edges become "notex".
```

[⇒Command List](#)

## Intersectcrvsf

**Usage** Intersectcrvsf(name,PD,formula)

**Description** Returns a list of intersects of a curve and curved face.

**Details** PD is plotting data of curve. Curved face is given by formula.

## Examples

```
Putpoint3d(["A", [0, -3, 0], "B", [0, 3, 2]]);
Spaceline("1", [A, B]);
fd=[
  "z=4-(x^2+y^2)", "x=R*cos(T)", "y=R*sin(T)",
  "R=[0, 2]", "T=[0, 2*pi]", "e"
];
Startsurf();
Sfbdparadata("1", fd);
Intersectcrvsf("1", "s13d1", fd); // The result [[0, 1.57, 1.52], [0, -1.91, 0.36]] will be shown
in the console.
ExeccmdC("1", [""]);
println("Intersect="+intercrvsf1);
Drawpoint3d(intercrvsf1);
Letter(Parapt(intercrvsf1_1), "ne", "P1");
Letter(Parapt(intercrvsf1_2), "ne", "P2");
```

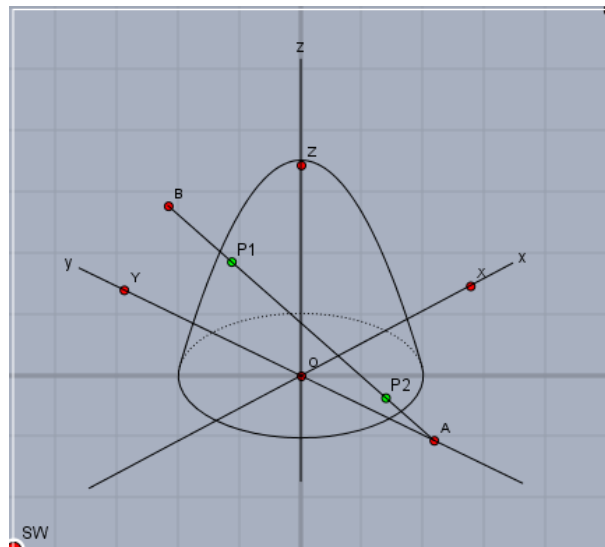

[⇒Command List](#)

## IntersectsgpL

**Usage** IntersectsgpL(name,segment,plane,option)

**Description** Returns a intersection of a line segment and plane.

**Details** Specify a line segment with two endpoints. Specify the plane as three points that it contains. Options are "put" or "I" or "e" .

put : Create geometric points

i : Draw a point if it is within a line segment

e : Draw a point if you meet on the plane

Following two programs return the same result.

```
IntersectsgpL("P", "A-B", "C-D-E");
IntersectsgpL("P", [A3d,B3d], [C3d,D3d,E3d]);
```

Return value is [pt,flag1,flag2,val1,val2]

pt : The coordinates of the intersection of the straight line and the plane. If the straight line and the plane are parallel and the intersection does not exist, the empty list [].

flag1 : True if the intersection is within the line segment, false otherwise

flag2 : True if intersection is in plane, false otherwise

val1,val2 :Parameter values for line segments, parameter values for planes

## Examples

Presence or absence of intersection and return value.

The return value of flag 1, flag 2 when changing p2 with the following script

```
p1=[1,-1,0];
p2=[0,0,1/2];
p3=[0,1,0];
p4=[-1,0,0];
p5=[0,0,1];
Spaceline("1", [p1,p2]);
Spaceline("2", [p3,p4,p5,p3]);
ret=IntersectsgpL("P", [p1,p2], [p3,p4,p5], "put");
println("flag1="+ret_2+": flag2="+ret_3);

p2=[0,0,1/2];          p2=[-1,1,1];
flag1=false : flag2=true    flag1=true : flag2=true
```

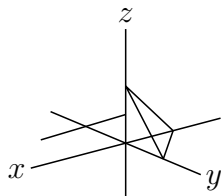

p2=[1,2,1];  
flag1=true : flag2=false

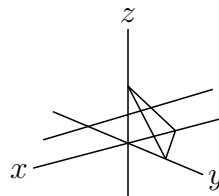

p2=[1,0,1/2];  
flag1=false : flag2=false

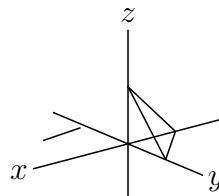
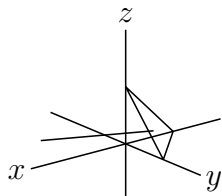

## Cutcube

```
Hn=3;
Putaxes3d(Hn);
Putpoint3d("A", [Hn,Hn,0]);
Putpoint3d("B", [Hn,0,Hn]);
Putpoint3d("C", [Hn,Hn,Hn]);
Putpoint3d("D", [0,Hn,Hn]);
Putonseg3d("E", X,B);
```

```

Putonseg3d("F",Z,B);
Putonseg3d("G",Z,D);
IntersectsgpL("M","A-C","E-F-G","put");
IntersectsgpL("N","D-Y","E-F-G","put");
phd=Concatobj([[O,X,A,Y],[X,A,M,E],[A,Y,N,M],[Y,N,G,Z,O],
              [O,Z,F,E,X],[Z,F,G],[E,M,N,G,F]]);
VertexEdgeFace("1",phd);
Nohiddenbyfaces("1","phf3d1");

```

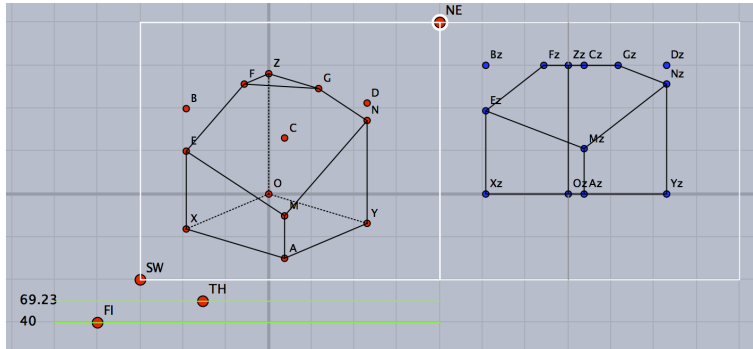

add next script (right figure)

```

Spaceline("1",[E,B,F],["do"]);
Spaceline("2",[B,C,M],["do"]);
Spaceline("3",[C,D,N],["do"]);
Spaceline("4",[D,G],["do"]);

```

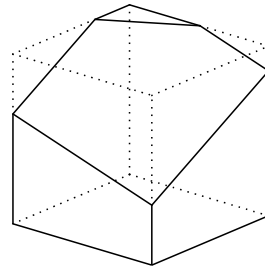
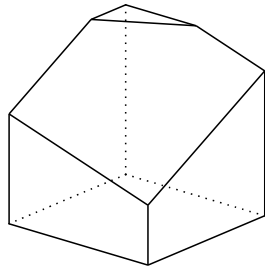

[⇒Command List](#)

## Sfcutparadatacgy

- Usage** Sfcutparadatacgy(name,string,list,options)
- Description** Obtain a line of intersection between a plane and a curved surface.
- Details** string is equation of plane, list is equation of a surface.
- Examples** Cross section of cone.

```

fd=[
  "p",
  "x=r*cos(t)","y=r*sin(t)","z=2*(2-r)",
  "r=[0,2]","t=[0,2*pi]","e"

```

```

];
Startsurf();
Sfbdparadata("1",fd);
Sfcutparadatacdy("1","y+2*z=3",fd);
ExeccmdC("1");

```

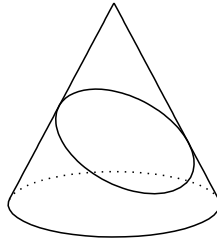

[⇒Command List](#)

## Partcrv3d

**Usage** Partcrv3d(name, start point, end point, PD)

**Description** Generic function to draw the part curve of the curve PD.

### Examples

```

Xyzax3data("", "x=[-5,5]", "y=[-5,5]", "z=[-5,4]");
Spacecurve("1", "[2*cos(t),2*sin(t),0.2*t]", "t=[0,4*pi]", ["Num=100"]);
PutonCurve3d("C", "sc3d1");
PutonCurve3d("D", "sc3d1");
Partcrv3d("1", C, D, "sc3d1", ["dr,3"]);
Letter([C, "n2", "C", D, "n2", "D"]);

```

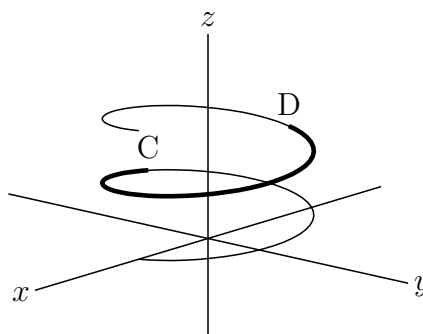

```

Spacecurve("1", "[2*cos(t),2*sin(t),0.2*t]", "t=[0,4*pi]", ["Num=10", "do"]);
Partcrv3d("1", 3.3, 8.5, "sc3d1"); // 3.3 and 8.5 are plotting data number of the
points.

```



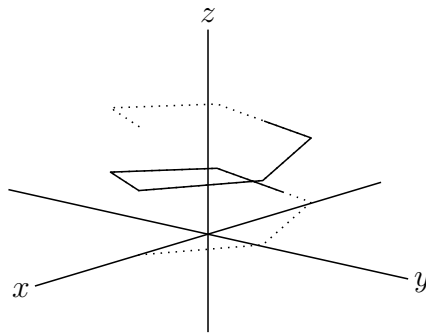

[⇒Command List](#)

## Reflectdata3d

**Usage** Reflectdata3d(name, list of PD, list, options)

**Description** Generic function to draw the reflection of plotting data.

### Examples

```
Putpoint3d(["A", [0, -2, 0], "B", [2, -2, 0], "C", [1, -2, 2], "D", [1, 0, 1],
"E", [1, 0, 0]]);
Spaceline("1", [A, B, C, A]);
```

Reflection on the point D

```
Reflectdata3d("1", ["s13d1"], [D3d], ["Color=blue", "dr, 2"]);
```

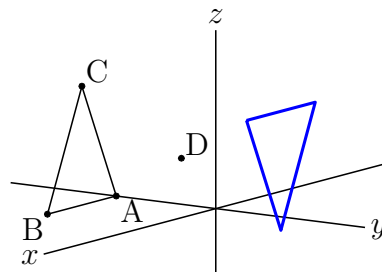

Reflection on the straight line DE

```
Reflectdata3d("1", ["s13d1"], [D3d, E3d], ["Color=blue", "dr, 2"]);
```

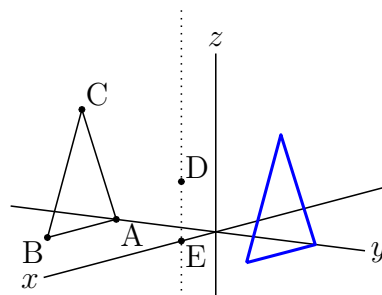

Reflection on the plane BDE

```
Reflectdata3d("1", ["s13d1"], [D3d, E3d, B3d], ["Color=blue", "dr, 2"]);
```

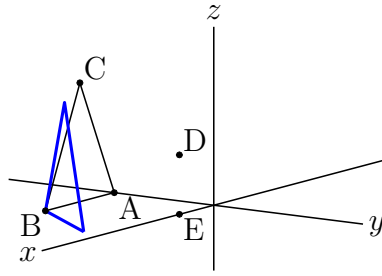

[⇒Command List](#)

## Reflectpoint3d

**Usage** Reflectpoint3d(coordinate,list)

**Description** Return the coordinate of the reflect point.

**Details** Argument "list" is the list of 3D-coordinate of the points. The following examples are the details.

### Examples

```
Reflectpoint3d(A3d, [B3d]); // reflection of the point A on the point B
Reflectpoint3d(A3d, [B3d,C3d]); // reflection of the point A on the line BC
Reflectpoint3d(A3d, [B3d,C3d,D3d]); // reflection of the point A on the plane BCD
```

[⇒Command List](#)

## Rotatedata3d

**Usage** Rotatedata3d(name, list of PD, vec, angle, options)

**Description** Generic function to rotate plotting data around the vector vec starting from the origin.

**Details** The options are the center point (the starting point of vec) and so on.

### Examples

```
Xyzax3data("", "x=[-5,4]", "y=[-5,5]", "z=[-5,4]", ["a", "0"]);
Putpoint3d(["A", [0,-2,0], "B", [2,-2,0], "C", [1,-2,2], "D", [1,-2,3]]);
Spaceline("1", [A,B,C,A]);
Spaceline("2", [C,D]);
Rotatedata3d("1", ["s13d1", "CD3d"], [0,0,1], pi/2, ["dr,2"]);
Letter([A,"s","A",B,"w","B",C,"ne","C",D,"ne","D"]);
```

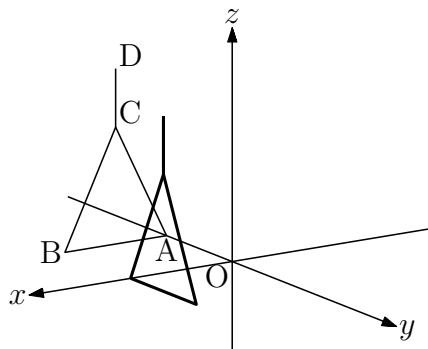

```
Rotatedata3d("1",["s13d1","CD3d"],[0,0,1],pi/2,[[1,0,0],"dr,2"]);
```

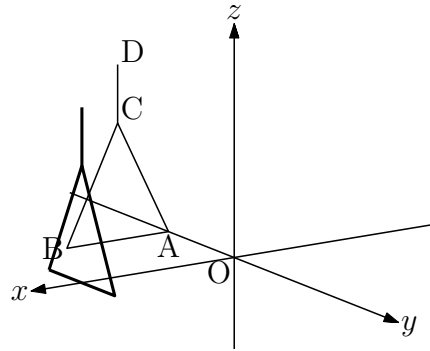

[⇒Command List](#)

## Rotatepoint3d

**Usage** Rotatepoint3d(coordinate,vec,angle,center)

**Description** Return the coordinate of the rotate point.

**Details** "vec"(3D-vector) represents the axis of rotation and "center" means the start point of 3D-vector. Default value of center is the origin (of the coordinate axes).

### Examples

```
Putpoint3d("A",[0,-1,0]);
Rotatepoint3d(A3d,[0,0,1],pi/2); // return value is [1,0,0].
Rotatepoint3d(A3d,[0,0,1],pi/2,[1,1,1]); // return value is [3,0,0].
```

[⇒Command List](#)

## Scaledata3d

**Usage** Scaledata3d(name, list of PD, vec, [options])

**Description** Generic function to scale plotting data.

**Details** Vec is a three-dimensional vector to express ratio. The center and options are given in a list.

### Examples

```
Putpoint3d(["A",[0,-2,0],"B",[2,-2,0],"C",[1,-2,2]]);
Spaceline("1",[A,B,C,A]);
Spacecurve("1","[cos(t)+1,sin(t)+1,1]","t=[0,2*pi]","[Num=100]");
Scaledata3d("1",["s13d1","sc3d1"],[2,2,2],[[0,0,0],"dr,2"]);
```

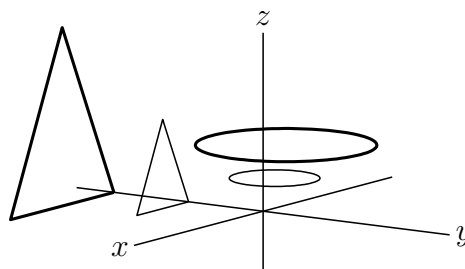

## Scalepoint3d

**Usage**      Scalepoint3d(point,vector,center)

**Description**    Execute scale transformation for the coordinate of the point.

**Details**      Scalepoint3d( $[a_i], [v_i], [c_i]$ ) =  $[(a_i - c_i)v_i + c_i]$

### Examples

```
Putpoint3d(["A", [2, -1, 2]]);
pt=Scalepoint3d(A3d, [3, 2, 4], [1, 1, 1]); //pt=[4, -3, 5]
Putpoint3d(["B", pt]);
```

## Translatedata3d

**Usage**      Translatedata3d(name, PD, vector)

**Description**    Generic function to translate plotting data.

### Examples

The curve sc3d1 is translated by 2 in the y axis direction. As a result, two curves parallel to the original curves are drawn.

```
Translatedata3d("1", ["sc3d1"], [0, 2, 0]);
```

Since polygons drawn with VertexEdgeFace() can not be translated by this function, parallel movement is performed by directly manipulating the surface data. For example, to draw a regular octahedron using the polyhedron data obj of Kobayashi, Suzuki, and Mitani, do the following. This is the case of parallel movement by 2 in the y axis direction.

```
Setdirectory( Dirhead+"/data/polyhedrons_obj");
phd=Readobj("r02.obj", ["size=2"]);
Setdirectory(Dirwork);
dn=length(phd_1);
repeat(dn,s,phd_1_s=phd_1_s+[0, 2, 0]);
VertexEdgeFace("1", phd);
```

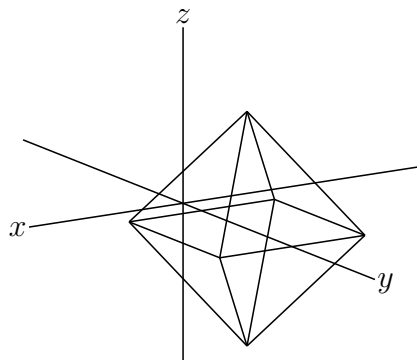

## Translatepoint3d

- Usage** Translatepoint3d(coordinate,vector)
- Description** Return the translated coordinate for the point.
- Details** Translatepoint3d( $[a_i], [v_i]$ ) =  $[a_i + v_i]$

### Examples

```
Putpoint3d(["A", [1,0,0]]);  
pt=Translatepoint3d(A3d, [-1,1,1]);  
Putpoint3d(["B", pt]);
```

[⇒Command List](#)

## 5.5 Others

### Perpplane

- Usage** Perpplane(name, point, vector, option)
- Description** Generic function to return the two points on the plane which is passing through the point and orthogonal to the vector.
- Details** The name is the two points name such as the form "A-B".  
Point is the name or the coordinate of the point through which the plane is passing.  
The vector is the normal of the plane.  
If option is "put" then the function draw two geometric points.

### Examples

Return the points A,B on the plane which is passing through the point P and orthogonal to the vector [1,1,1]

```
. Perpplane("A-B", "P", [1,1,1], "put");
```

Return the points A,B on the plane which is passing through the point P and orthogonal to the line segment OP. In this situation PA and PB is orthogonal and length of PA and PB are 1.

```
. Perpplane("A-B", "P", P3d-O3d);
```

Draw point A,B,C,D by draw tool of Cinderella.

```
Xyzax3data("", "x=[-5,5]", "y=[-5,5]", "z=[-5,4]");  
Putpoint3d(["O", [0,0,0]]);  
Putpoint3d(["P", [1,1,1]]);  
Perpplane("E-F", "P", P3d-O3d, "put");  
vec1=2*(E3d-P3d);  
vec2=2*(F3d-P3d);  
Putpoint3d(["A", P3d+vec1+vec2]);  
Putpoint3d(["B", P3d+vec1-vec2]);  
Putpoint3d(["C", P3d-vec1-vec2]);  
Putpoint3d(["D", P3d-vec1+vec2]);  
Spaceline("1", [A,B,C,D,A]);
```

```

Arrowdata([O,P],["dr,2"]);
Letter([P,"w","P",A,"ne","A",B,"e","B",C,"ws","C",D,"nw","D",]);
Skeletonparadata("1");

```

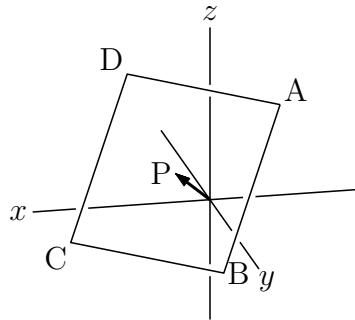

[⇒Command List](#)

## Perppt

**Usage**           Perppt(name, point, list of points, option)

**Description**   Generic function to get the foot of a perpendicular for the plane from the point.

**Details**         We specify the plane by the list of points.

Option is the following.

"draw": draw the point, don't make the geometric point(default).

"put" : make the geometric point.

"none": only make the data and don't draw.

### Examples

We get the coordinate of the point H in the variable H3d for the following examples.

```
Perppt("H", "O", "A-B-C", "none");
```

```
Perppt("H", "O", "A-B-C");
```

```
Perppt("H", "O", "A-B-C", "put");
```

#### Example

```
Xyzax3data("", "x=[-5,5]", "y=[-5,5]", "z=[-5,4]");
```

```
Putpoint3d("O", [0,0,0]);
```

```
Putpoint3d("A", [3,0,0]);
```

```
Putpoint3d("B", [0,3,0]);
```

```
Putpoint3d("C", [0,0,3]);
```

```
Perppt("H", "O", "A-B-C", "put");
```

```
Spaceline("1", [A,B,C,A]);
```

```
Spaceline("2", [O,H]);
```

```
Letter([A,"nw","A",B,"ne","B",C,"ne","C",O,"nw","O",H,"ne","H"]);
```

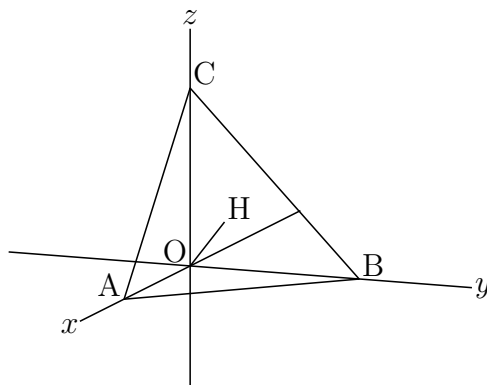

⇒Command List

## Projcoordpara

**Usage** Projcoordpara(3D-coordinate)

**Description** Generic function to get the projection coordinate on the Euclidean view coordinate system.

### Examples

```
println(Projcoordpara([3,1,2])); //printed value is such as [-0.65, 1.7, 3.27] where
the third element means the (signed) distance from the projection plane.
```

⇒Command List

## Readobj

**Usage** Readobj(filename, option)

**Description** Read in the polyhedron data in the folder name polyhedrons\_obj

### Details

Data of all Johnson solid can be downloaded from

<http://mitani.cs.tsukuba.ac.jp/polyhedron/>

Store the folder into the work folder of KETCindy for example, and execute

```
Setdirectory(gethome+"/ketcindy/polyhedrons_obj");
polydt=Readobj("r02.obj",["size=2"]);
Setdirectory(Dirwork);
```

Then the data of r02.obj are assigned to the variable polydt.

Option is ["size=n"] then we get the magnification of n times. If n is negative value then we have the image of vertical inversion.

### Examples

```
VertexEdgeFace("1",polydt); //output data name is phf3d1
Nohiddenbyfaces("1","phf3d1");
```

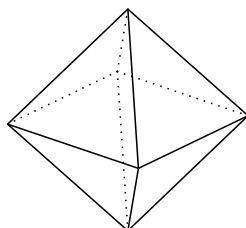

The main polyhedral data is as follows.

No	name	No	name	No	name
r01	Tetrahedron	s02	Icosidodecahedron	s08	Rhombicuboctahedron
r02	Octahedron	s03	Truncatedtetrahedron	s09	Rhombicosidodecahedron
r03	Cube	s04	Truncatedoctahedron	s10	Truncatedcuboctahedron
r04	Dodecahedron	s05	Truncatedcube	s11	Truncatedicosidodecahedron
r05	Icosahedron	s06	Truncatedicosahedron	s12L/R	snubcube
s01	Cuboctahedron	s07	Truncateddodecahedron	s13L/R	Snubdodecahedoron

[⇒Command List](#)

## XYZCOORD

**Usage** XYZCOORD(P.x, P.y, Pz.y)

**Description** Generic function to return the 3D-coordinate of the point P.

**Details** (P.x, P.y) is the coordinate of P in the mainarea and Pz.y is the y-coordinate of P in the subarea.

### Examples

```
println(XYZCOORD(A.x,A.y,Az.y)); //print the 3D-coordinate of point A on the console.
```

[⇒Command List](#)

## ISANGLE

**Usage** ISANGLE()

**Description** Decide the selection of the angle slider.

**Details** Returns “true” if select slider, and “false” if not.

In drawing including hidden line processing, reaction is bad when recalculating while moving the viewpoint. With this function, you can write code that does not recalculate while moving the viewpoint.

### Examples

```
fd=[
"z=4-(x^2+y^2)",
"x=R*cos(T)", "y=R*sin(T)",
"R=[0,2]", "T=[0,2*pi]", "e" \verb ];|
if(ISANGLE(),
Sf3data("1",fd);
,
Startsurf();
Sfbdparadata("1",fd);
Crvsfparadata("1", "ax3d", "sfbd3d1", fd);
ExecCmdC("1");
);
```



## Dist3d

**Usage**        `Dist3d(a1,a2)`

**Description**    Generic function to get the 3D-distance of two points.

### Examples

Following three programs return the same result.

```
Dist3d("A","B");
Dist3d(A,B);
Dist3d(A3d,B3d);
```

⇒Command List

## Embed

**Usage**        `Embed(name,PDlist,formula,varlist)`

**Description**    Embed plotting data of 2D in plane of 3D.

**Details**        PDlist is list of plotting data of 2D. Plane of 3D is given by formula and varlist.

### Examples

Embed an equilateral triangle and its circumscribed circle in a plane in 3D space.

(1) `vo`, `vx`, `vy` are defined with function `Defvar` that uses `R`.

```
XYZax3data("", "x=[-5,4]", "y=[-10,4]", "z=[-5,5]", ["a", "0"]);
Spaceline("1", [[3,0,0], [3,6,0], [3,6,6], [3,0,6], [3,0,0]]);
Defvar("vo=[3,3,3]"); // Defined in R
Defvar("vx=[0,1,0]"); // Defined in R
Defvar("vy=[0,0,1]"); // Defined in R
Putpoint3d(["A", [3,3,3]]);
Circledata("1", [[0,0], [2,0]], ["nodisp"]);
Listplot("1", [[0,2], [-sqrt(3),-1], [sqrt(3),-1], [0,2]], ["nodisp"]);
Embed("1", ["cr1", "sg1"], "vo+x*vx+y*vy", "x,y");
Ptsize(3);
Drawpoint(A);
```

Following view is as `TH=75,FI=70`.

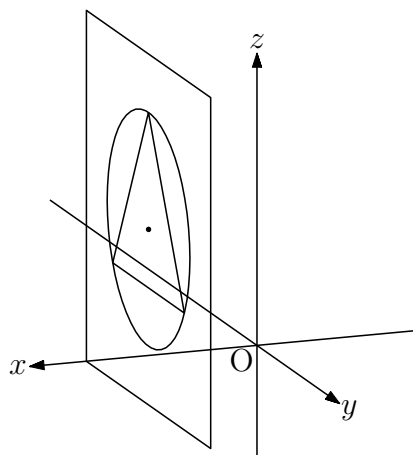

(2) A, B, and C are defined instead of vo, vx, vy defined by Defvar. But, in this case, points B and C are not drawn in the plane. So, the figure may be difficult to understand.  
`Putpoint3d(["A", [3,3,3], "B", [0,1,0], "C", [0,0,1]]);`  
`Embed("1", ["cr1", "sg1"], "A3d+x*B3d+y*C3d", "[x,y]");`

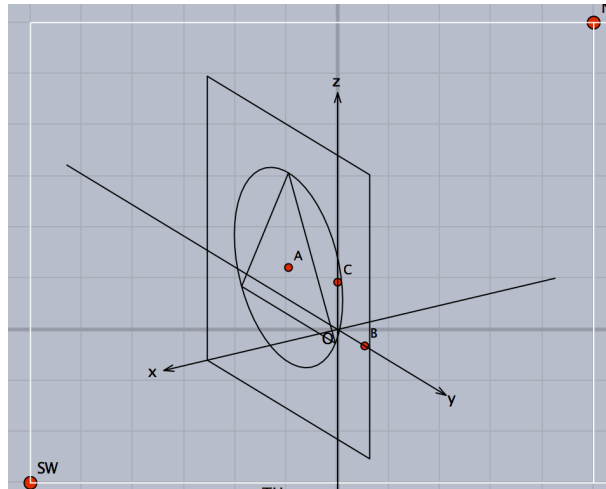

To draw the B and C on the embedded figure, code changes as follows.

```
Putpoint3d(["A", [3,3,3], "B", [3,4,3], "C", [3,3,4]]);
Embed("1", ["cr1", "sg1"], "A3d+x*B3d+y*C3d", "[x,y]");
```

(3) The function `Perpplane` is used in next.

```
Xyzax3data("", "x=[-5,5]", "y=[-8,5]", "z=[-5,5]");
Putpoint3d(["O", [0,0,0], "P", [1,1,2]]);
Perpplane("E-F", "P", P3d-O3d, "put");
vec1=3*(E3d-P3d);
vec2=3*(F3d-P3d);
Putpoint3d(["A", P3d+vec1+vec2]);
Putpoint3d(["B", P3d+vec1-vec2]);
Putpoint3d(["C", P3d-vec1-vec2]);
Putpoint3d(["D", P3d-vec1+vec2]);
Spaceline("1", [A,B,C,D,A]);
Circledata("1", [[0,0], [2,0]], ["nodisp"]);
Listplot("1", [[0,2], [-sqrt(3), -1], [sqrt(3), -1], [0,2]], ["nodisp"]);
Embed("1", ["cr1", "sg1"], "P3d+x*(E3d-P3d)+y*(F3d-P3d)", "[x,y]");
Ptsize(3);
Drawpoint(P);
Skeletonparadata("1");
```

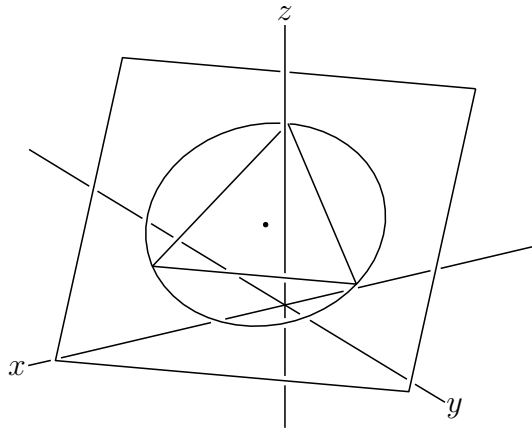

[⇒Command List](#)

## Parapt

**Usage** Parapt(3D-coordinate)

**Description** Generic function to return the 2D-coordinate on the plane of projection for the 3D-point.

### Examples

```
println(Parapt([2,1,5]));
```

[⇒Command List](#)

## Invparapt

**Usage** Invparapt(coordinate,PD)

**Description** Returns the point on the curve that is corresponding to the coordinates on the Euclidean view.

**Details** Returns the 3D-coordinates of the point on the curve(PD) from the coordinate on the Euclidean view.

### Examples

Find on the screen (not in the space) intersection points (tmp\_1, tmp\_2, ...) of the spiral curve and the space line. Draw a part of the spiral whose end points (p1 and p2) are selected from the intersection points.

```
Spaceline("1", [[-1,-1,-1], [1,2,3]]);
Spacecurve("1", "[2*cos(t), 2*sin(t), 0.2*t]", "t=[0,4*pi]", ["do"]);
tmp=Intersectcrvs("s12d1", "sc2d1");
p1=Invparapt(tmp_1, "sc3d1");
p2=Invparapt(tmp_2, "sc3d1");
Partcrv3d("1", p1, p2, "sc3d1");
```

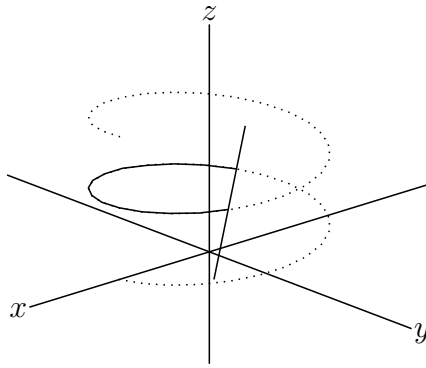

[⇒Command List](#)

## Expr3D

**Usage** Expr([position, direction, string],options)

**Description** Display the string.

**Details** The position is the space coordinate. Other than that it is the same as Expr().

[⇒Command List](#)

## Letter3D

**Usage** Letter([position, direction, string],options)

**Description** Display the string.

**Details** The position is the space coordinate. Other than that it is the same as Letter().

### Examples

```
Putpoint3d("A",2*[0,0,2*sqrt(6)/3]);
Putpoint3d("B",2*[1,-1/sqrt(3),0]);
Putpoint3d("C",2*[0,sqrt(3)-1/sqrt(3),0]);
Putpoint3d("D",2*[-1,-1/sqrt(3),0]);
Putpoint3d("M", (B3d+C3d)/2);
phd=Concatobj([ [A,B,C], [A,B,D], [A,C,D], [B,C,D] ]);
VertexEdgeFace("1",phd);
Spaceline("1", [A,M,D]);
Nohiddenbyfaces("1", "phf3d1");
Letter3d([A3d,"ne", "A",B3d,"w", "B",C3d,"se", "C",D3d,"e", "D"]);
Letter3d(M3d,"sw", "M", ["Color=blue"]);
```

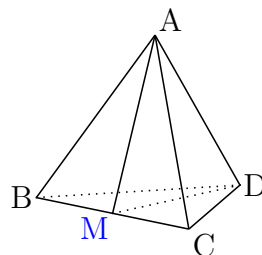

[⇒Command List](#)

## 6 KeTCindyJS

### 6.1 How to create HTML

KeTCindy can create the HTML file from a KeTCindy file using CindyJS.

- (1) Use a KeTCindy file with buttons of KeTJS in CindyScreen, for example, templateketcindyjs.cdy.
- (2) Select from the top menu, **File > Export to CindyJS**.
- (3) Press button "KeTJS" for on-line mode, or "KeTJSoff" for off-line mode.
- (4) Then the HTML file will be created in the same folder of the cdy file.

### 6.2 Control of code writing

- no ketjs (on/off) for not writing to HTML
- only ketjs (on/off) for only writing to HTML
- on, off are used for multi lines of scripts.

#### Example

```
str="x^2"; //no ketjs
//str=Textedit(0); //only ketjs
```

### 6.3 Commands of KeTCindyJS

#### Ptpos

**Usage**            Ptpos(geometric point)  
**Description**    Function to return the latest position  
**Examples**        Ptpos(A)

[⇒Command List](#)

#### Setketcindyjs

**Usage**            Setketcindyjs( list of options )  
**Description**    Function to set options of KeTCindyJS.

#### Options

"Scale="            Ratio of scaling (default : 1)  
"Nolabel="          list of points without label. all can be used  
"Color="            Name or code of background color (default : lightgray)  
"Grid="             Grid size (mm)  
"Figure=y"          To set window size to that of KeTCindy  
"Axes=false"        Not to display axes of Cinderella

**Example**         Setketcindyjs(["Nolabel=all","Grid=2","Color=white"]);

[⇒Command List](#)

## Ketcindyjsdata

**Usage** Ketcindyjsdata( list of name, value of variables )

**Description** Function to write the variables into "csinit".

### Examples

```
Mxfun("1","integrate",["x*sin(x)","x"]);// no ketjs
Ketcindyjsdata(["mx1",mx1]);
Plotdata("1",mx1,"x");
```

[⇒Command List](#)

## Ketcindyjsmain

**Usage** Ketcindyjsbody( prependlist, appendlist)

**Description** Function to add scripts to the first/last of body tag.

### Examples

```
Ketcindyjsbody(["<pf10red/fp>_;;Title"],[]);
=> <p><font size="10" color="red">&emsp;&emsp;Title</font></p>
```

[⇒Command List](#)

## Animationparam

**Usage** Animationparam(init, speed( /sec), range )

**Description** to get parameter value of buttons for animation.

**Examples** ss=Animationparam(0,1,[-60,60]);

### Buttons

- "Play" Parameter value set to the initial value, and starts changing
- "Stop" Parameter value set to the initial value, and ends changing

[⇒Command List](#)

## Seteditable

**Usage** Setedittextt(number of identifier,[character string,character size, box width])

**Description** Function to set Editable Text.

**Remark** To create Editable Text,

- (1) Select "Mode/Special/Editable Text".
- (2) Move with shift-clicking
- (3) With the inspector, confirm/change the number of identifier.

**Examples** Let the number of identifier be 50.

```
Setedit(50,["y=", "Size=18", "Width=200"]);
```

## Textedit

**Usage**            Texedit(number of identifier)

**Description**    Function to get a string from an input box in HTML.

**Examples**        Let the number of identifier be 50.

```
str="x^2";  
//str=Textedit(50); //only ketjs  
Plotdata("1",str,"x");
```

## Movetojs

**Usage**            Movetojs(identifier or name,position,font size )

**Description**    Function to set the position and font size of text box in HTML.

**Example**         Movetojs(50,[0,-5],15);// no ketjs

## Setplaybuttons

**Usage**            Setplaybuttons(coord, font size [, space])

**Description**    Function to set the position of play buttons in HTML.

**Example**         Setplaybuttons([0,-5],15,[1]);// no ketjs

## 7 Appendix

### 7.1 To use other text editor

For example, let the cdyfile be `template.cdy`.

- (1) Create `template.txt` and put it in the same folder as the cdy file.
- (2) Describe in Figures slot as follows, and execute.

```
Ketinit();  
setdirectory(Dircdy);  
import(Cdynam(''.txt''));  
setdirectory(Dirwork);  
Windispg();
```

- (3) Write scripts in `template.txt` and save it.  
Ex) `Putpoint("A",[0,0],A.xy);`  
`Plotdata("1','x^2','x');`
- (4) Click any position on the screen.



## 7.2 Color table

name	CMYK	Color	name	CMYK	Color
greenyellow	[0.15,0,0.69,0]		royalpurple	[0.75,0.9,0,0]	
yellow	[0,0,1,0]		blueviolet	[0.86,0.91,0,0.04]	
goldenrod	[0,0.1,0.84,0]		periwinkle	[0.57,0.55,0,0]	
dandelion	[0,0.29,0.84,0]		cadetblue	[0.62,0.57,0.23,0]	
apricot	[0,0.32,0.52,0]		cornflowerblue	[0.65,0.13,0,0]	
peach	[0,0.5,0.7,0]		midnightblue	[0.98,0.13,0,0.43]	
melon	[0,0.46,0.5,0]		navyblue	[0.94,0.54,0,0]	
yelloworange	[0,0.42,1,0]		royalblue	[1,0.5,0,0]	
orange	[0,0.61,0.87,0]		blue	[1,1,0,0]	
burntorange	[0,0.51,1,0]		cerulean	[0.94,0.11,0,0]	
bittersweet	[0,0.75,1,0.24]		cyan	[1,0,0,0]	
redorange	[0,0.77,0.87,0]		processblue	[0.96,0,0,0]	
mahogany	[0,0.85,0.87,0.35]		skyblue	[0.62,0,0.12,0]	
maroon	[0,0.87,0.68,0.32]		turquoise	[0.85,0,0.2,0]	
brickred	[0,0.89,0.94,0.28]		tealblue	[0.86,0,0.34,0.02]	
red	[0,1,1,0]		aquamarine	[0.82,0,0.3,0]	
orangered	[0,1,0.5,0]		bluegreen	[0.85,0,0.33,0]	
rubinered	[0,1,0.13,0]		emerald	[1,0,0.5,0]	
wildstrawberry	[0,0.96,0.39,0]		janglegreen	[0.99,0,0.52,0]	
salmon	[0,0.53,0.38,0]		seagreen	[0.69,0,0.5,0]	
carnationpink	[0,0.63,0,0]		green	[1,0,1,0]	
magenta	[0,1,0,0]		forestgreen	[0.91,0,0.88,0.12]	
violetred	[0,0.81,0,0]		pinegreen	[0.92,0,0.59,0.25]	
rhodamine	[0,0.82,0,0]		limegreen	[0.5,0,1,0]	
mulberry	[0.34,0.9,0,0.02]		yellowgreen	[0.44,0,0.74,0]	
redviolet	[0.07,0.9,0,0.34]		springgreen	[0.26,0,0.76,0]	
fuchsia	[0.47,0.91,0,0.08]		olivegreen	[0.64,0,0.95,0.4]	
lavender	[0,0.48,0,0]		rawsienna	[0,0.72,1,0.45]	
thistle	[0.12,0.59,0,0]		sepia	[0,0.83,1,0.7]	
orchid	[0.32,0.64,0,0]		brown	[0,0.81,1,0.6]	
darkorchid	[0.4,0.8,0.2,0]		tan	[0.14,0.42,0.56,0]	
purple	[0.45,0.86,0,0]		gray	[0,0,0,0.5]	
plum	[0.5,1,0,0]		black	[0,0,0,1]	
violet	[0.79,0.88,0,0]		white	[0,0,0,0]	

Rem) lightgray [0,0,0,0.15], offwhite [0,0,0,0.3], cindycolor [0.66,0,69,0.71] have been added.

### 7.3 Comparative chart of drawing of points

return : use return value  
 draw : draw Euclidean view  
 geo : make geometric point on Euclidean view  
 Tex : output Tex file

command	return	draw	geo	TeX
Pointdata	-	○	-	○
Putpoint	-	-	○	-
Putintersect	-	-	○	-
PutonCurve	-	-	○	-
PutonLine	-	-	○	-
PutonSeg	-	-	○	-
Reflectpoint	○	-	-	-
Rotatepoint	○	-	-	-
Scalepoint	○	-	-	-
Translatepoint	○	-	-	-
Pointdata3d	-	○	-	○
Putpoint3d	-	-	○	-
Intersectcrvsf	△	-	○	-
IntersectsgpL	-	○	○	-
Invparapt	○	-	-	-
Parapt	○	-	-	-
Perpplane	-	○	○	-
Perppt	-	○	○	-
Pointdata3d	-	○	-	○
PutonCurve3d	-	-	○	-
PutonSeg3d	-	-	○	-
Reflectpoint3d	○	-	-	-
Rotatepoint3d	○	-	-	-
Scalepoint3d	○	-	-	-
Translatepoint3d	○	-	-	-

△ : use PD

## 8 Command List

To index

<a href="#">Addax</a>	decide axis are drawn or not.
<a href="#">Addpackage</a>	add packages of $\text{\TeX}$ to the main file for previewing.
<a href="#">Anglemark</a>	draw an angle mark.
<a href="#">Animationparam</a>	Get parameter value of animation
<a href="#">Arrowdata</a>	draw an arrow line between two points.
<a href="#">Arrowhead</a>	draw an arrowhead with specified direction at a designated point.
<a href="#">Asin</a>	return arcsine and arccosine.
<a href="#">Asirfun</a>	execute Risa/Asir's function.
<a href="#">Assign</a>	replace the string1 in the string0 with the string2.
<a href="#">Assign</a>	replace the string1 in the string0 with the string2.
<a href="#">BBdata</a>	return the size of an image file.
<a href="#">Bezier3d</a>	draw a Cubic Bézier curve.
<a href="#">Beziersmooth</a>	draw a smooth Bezier curve.
<a href="#">Beziersym</a>	draw a smooth Bezier curve.
<a href="#">Bezier</a>	draw a Bezier curve.
<a href="#">Bowdata</a>	draw the shape of bow connecting two points.
<a href="#">Boxplot</a>	draw boxplots.
<a href="#">Bspline</a>	draw second degree B-spline curve.
<a href="#">CalcbyA</a>	execute Risa/Asir's script.
<a href="#">CalcbyM</a>	execute Maxima's script.
<a href="#">CalcbyR</a>	executes R commands and returns the execution result to Cinderella.
<a href="#">CalcbyW</a>	execute scripts of Wolfram language(WL).
<a href="#">Changestyle3d</a>	change the attribute of PD.
<a href="#">Changestyle</a>	change the option for drawing.
<a href="#">Changetablestyle</a>	change line styles of rules.
<a href="#">Changework</a>	change the working directory.
<a href="#">Cindyname</a>	return the name of a current file.
<a href="#">Circledata</a>	draw a circle or polygon.
<a href="#">Colorcode</a>	change colorcode from colortype1 to colortype2.
<a href="#">Concatobj</a>	concatenates several objects.
<a href="#">Crossprod</a>	return the cross product of 2 vectors.
<a href="#">CRspline</a>	draw single Catmull-Rom spline curve.
<a href="#">Crvsfparadata</a>	remove curves hidden by curved face.
<a href="#">Datalist2d</a>	get a list of 2D-plotting data on the screen.
<a href="#">Datalist3d</a>	get a list of 3D-plotting data.
<a href="#">Deffun</a>	define a function common to both Cindy and R.
<a href="#">Definecolor</a>	define the name of colorcode in the $\text{\TeX}$ figure.
<a href="#">Defvar</a>	define variables common to both Cindy and R.
<a href="#">Deqplot</a>	draw the solution curve of a differential equation.
<a href="#">Derivative</a>	find the derivative of a function or a plotting data.
<a href="#">Dispmat</a>	display the list in the console matrix.
<a href="#">Dist3d</a>	get the 3D-distance of two points.
<a href="#">Dotfilldata</a>	fill a domain with dots.
<a href="#">Dotprod</a>	return the dot product of 2 vectors.
<a href="#">Dqq</a>	return the string surrounded by double quotes.
<a href="#">Drawfigures</a>	manipulate a plural number of PDs together.
<a href="#">Drawpoint3d</a>	draw 3D-points.

<a href="#">Drawppoint</a>	draw a point.
<a href="#">Drwxy</a>	draw axis in the $\text{\TeX}$ figure.
<a href="#">Ellipseplot</a>	draw ellipse.
<a href="#">Embed</a>	embed plotting data of 2D in plane of 3D.
<a href="#">Enclosing</a>	make a closed curve form the list of plotting data.
<a href="#">ExeccmdC</a>	draw 3D-surface.
<a href="#">Expr3d</a>	display the string.
<a href="#">Exprrot</a>	write a rotated expression in $\text{\TeXstyle}$ .
<a href="#">Expr</a>	write an expression in $\text{\TeXstyle}$ .
<a href="#">Extractdata</a>	add properties to a data.
<a href="#">Factorial</a>	return the factorial.
<a href="#">Figpdf</a>	make a pdf file with the same size of figure.
<a href="#">Findarea</a>	return the area enclosed with a close curve.
<a href="#">Findcell</a>	return the information of a cell.
<a href="#">Findlength</a>	return the length of a curve.
<a href="#">FontSize</a>	define the font size in the $\text{\TeX}$ figure.
<a href="#">Fourierseries</a>	draw the graph of a fourier series.
<a href="#">Fracform</a>	return TeX-like form of the fraction.
<a href="#">Framedata</a>	draw a rectangle.
<a href="#">Hatchdata</a>	draw hatch lines in the close curve.
<a href="#">Help</a>	display usages of the function.
<a href="#">Histplot</a>	create histograms.
<a href="#">Htickmark</a>	tick on the horizontal ax.
<a href="#">Hyperbolaplot</a>	draw a hyperbola.
<a href="#">Implicitplot</a>	draw the graph of a implicit function.
<a href="#">Indexall</a>	return all positions of string2 in string1.
<a href="#">Initglist</a>	add the list in ketlib slot to that of figures slot.
<a href="#">Integrate</a>	find the value of numerical integration.
<a href="#">Intersectcrvsf</a>	return a list of intersects of a curve and curved face.
<a href="#">IntersectcurvesPp</a>	return a list of intersects with parameters of 2 plotting data.
<a href="#">Intersectcurves</a>	return a list of intersects of 2 plotting data.
<a href="#">IntersectsgpL</a>	return a intersection of a line segment and plane.
<a href="#">Inversefun</a>	find the value of the inversefunction.
<a href="#">Invert</a>	rearrange plotting data in the reverse order.
<a href="#">Invparapt</a>	return the point on the curve.
<a href="#">Joincrvs</a>	create a plotting data of connecting in list of plotting data.
<a href="#">Ketcindyjsdata</a>	Write into csinit
<a href="#">Ketcindyjsbody</a>	Add scripts to the first/last of body tag
<a href="#">Ketinit3d</a>	declare the use of KeTCindy3D
<a href="#">Ketinit</a>	initialize $\text{\KeTCindy}$ .
<a href="#">Letter3d</a>	display the string.
<a href="#">Letterrot</a>	rotate a string and display it.
<a href="#">Letter</a>	display the string.
<a href="#">Lineplot</a>	draw the straight line through the two points.
<a href="#">Listplot</a>	connect points by line segments.
<a href="#">Mkbeziercv</a>	draw some bezier curves.
<a href="#">Mkbezierpterv3d</a>	draw a cubic Bezier curve from nodes.
<a href="#">Mkbezierpterv</a>	draw a bezier curve.
<a href="#">Mkcircles</a>	create plotting data of all geometric circles.
<a href="#">Mkobjcmd</a>	obj formatted files of surfaces without thickness.

Mkobjcrvcmnd	obj formatted files of spatial curves.
Mkobjnrm	calculate normal vector of surface.
Mkobjplatecmnd	obj formatted files of plates.
Mkobjpolycmnd	obj formatted files of polyhedra.
Mkobjsymbcmnd	generate commands for obj formatted files of some characters.
Mkobjthickcmnd	generate commands for obj formatted files of surfaces with thickness.
Mksegments	create plotting data of all geometric segments.
Mkviewobj	generate obj formatted files.
Movetojs	Set position and fontsize of text box in HTML
Mxbatch	make a command to execute the Maxima file.
Mxfun	execute Maxima's function.
Mxtex	convert expression to TeX format.
Nearestptcrv	return the nearest point on the plotting data from the point1.
Nearestpt	return the nearest point with the parameter and the distance.
Nohiddenbyfaces	draw hidden lines by the surfaces.
Norm	return the norm of a vector.
Numptcrv	return the number of plotting data.
Op	return the n-th element of a list or a string.
Ospline	draw a spline curve of Oshima.
Ovaldata	draw a rectangle with rounded corners.
Parabolaplot	draws a parabola.
Paramark	draw an angle mark with a parallelogram.
Paramoncurve	return the parameter value of the point on the curve.
Paramplot	draw a curve of parametric representation.
Parapt	return the 2D-coordinate on the plane.
Partcrv3d	draw the part curve of the curve PD.
Partcrv	make a piece of curve from the PD.
Periodfun	draw the graph of a periodic function.
Perpplane	create a basic vector on a vertical plane
Perppt	get the foot of a perpendicular for the plane from the point.
Phparadata	draw the polyhedron by performing hidden line processing.
PlotdataR	draw graph of R's statistical probability function.
Plotdata	draw the graph of function.
Pointdata3d	generate data of point list.
Pointdata	make a point data.
Pointoncurve	point which has the parameter value
Polarplot	draw a curve of polar equation.
Polygonplot	draw a polygon inscribed inside the circle.
Projcoordpara	get the projection coordinate.
Ptcrv	Returns n-th point from PD.
Ptpos	Return the latest position of geometric point
Ptselected	tests whether the point is selected.
Ptsize	set the size of points.
Ptstart, Ptend	returns start point and end point of PD.
Putaxes3d	make the geometric points on the coordinate axis.
Putcellexpr	put a math expression at the cell.
Putcell	put a string at the cell.
Putcolexpr	put math expressions to a column.
Putcol	put strings to a column.
Putintersect	make a intersection point of two curves.

PutonCurve3d	make the geometric point on the 3D-curve.
Putonseg	put a point on the segment.
PutonCurve	put a point on the curve.
PutonLine	put a point on the line.
Putonseg3d	make the geometric point on the 3D-segment.
Putpoint3d	draw the geometric point in the space.
Putpoint	put a point.
Putrowexpr	put math expressions to a row.
Putrow	put strings to a row.
Readcsv	read a file in csv format.
Readlines	read a text file line by line.
Readobj	read in the polyhedron data in the folder name <code>polyhedrons_obj</code>
ReadOutData	read external data.
Reflectdata3d	draw the reflection of plotting data.
Reflectdata	draw a reflective curve.
Reflectpoint3d	return the coordinate of the reflect point.
Reflectpoint	return the reflect point.
Reparse	return the real part after parsing.
Rfun	execute a R command.
Rotatedata3d	rotate plotting data around the vector
Rotatedata	rotate plotting data.
Rotatepoint3d	return the coordinate of the rotate point.
Rotatepoint	rotate a point.
Rulerscale	put ruler marks.
Scaledata3d	scale plotting data
Scaledata	scale plotting data.
Scalepoint3d	execute scale transformation for the coordinate of the point.
Scalepoint	scale a point.
Segmark	add a mark to a segment.
Setarrow	set styles of arrows.
Setarrow	set the style of arrow.
Setax	set the style of axis.
SetColor	set the color of figures and characters in the $\TeX$ figure.
Seteditable	Set Editable Text
Setfiles	set the name of texfile.
Setketcindyjs	Set options of KeTCindyJS
Setmarklen	set the length of tickmarks on the axis.
Setorigin	set or transtate the coordinate of apparent origin.
Setpara	set up the animation control system.
Setparent	set the name of texfile by using the Parent push button.
Setpen	set the thickness of lines.
Setplaybuttons	Set position of play buttons in HTML
Setpt	set the size of points.
Setscaling	set the scale of vertical direction.
Setslidebody	set up the color and density of the letters in slide body.
Setslidehyper	use <code>hyperref.sty</code> .
Setslidemain	set up the main slide.
Setslidemargin	change the margin of slides.
Setslidepage	set up each page of slides.
SetTitle	make a title slide.

Setunitlen	set the scale of unit length. (default is 1cm)
Setwindow	set a drawing area on a Euclidean view.
Sf3data	draw the wire frame model of the surface.
Sfbdparadata	draw the surface by performing hidden line processing.
Sfcutparadatacdy	Display intersection line of surface and surface.
Shade	fill a domain surrounded by a closed curve.
Skeletonparadata	draw the lines by performing hidden line processing.
Slider	make a slider on a Euclidean view.
Spacecurve	draw the space curve.
Spaceline	draw the space polygonal lines.
Sprintf	converts a real number to a string.
Sqr	return square root.
Start3d	creates subarea, and recognize 3D points.
Startsurf	defines values related to surface rendering.
Strsplit	return the list of strings separated by a string.
Tab2list	convert contents of string data to list.
Tabledata	draw rules of a table.
Tangentplot	draw a tangent line of a plotting data.
Texcom	add the command in the $\text{\TeX}$ file.
Textedit	Get string from input box of KeTCindyJS
Textformat	converts a real number to a string.
Tgrid	return the coordinates of the grid name.
Tlistplot	connect two lattice points by line segments.
Tocindyform	return Cindy form.
Tonormalform	return TeX form with $*$ .
Totexform	return TeX form.
Toupper	return the upper case letters of a string.
Translatedata3d	translate plotting data
Translatedata	translate plotting data.
Translatepoint3d	return the translated coordinate for the point.
Transeatepoint	translate a point.
Usegraphics	change to pict2e.
Vertexedgeface	draw the polyhedron.
Vtickmark	tick on the vertical ax.
Windispg	display all graphs on Euclidean view.
Wireparadata	draw the surface by wire frame data with performing hidden line processing.
Wlfun	execute a function of Wl.
Wltex	convert expression to LaTeX format.
Writecsv	make a CSV file consisting of the contents of data.
WriteOutData	write out data in KeTCindy format.
Xyzax3data	draw the coordinate axis.
Xyzcoord	return the 3D-coordinate of the point P.